

Wood gas as engine fuel

FAO
FORESTRY
PAPER

72

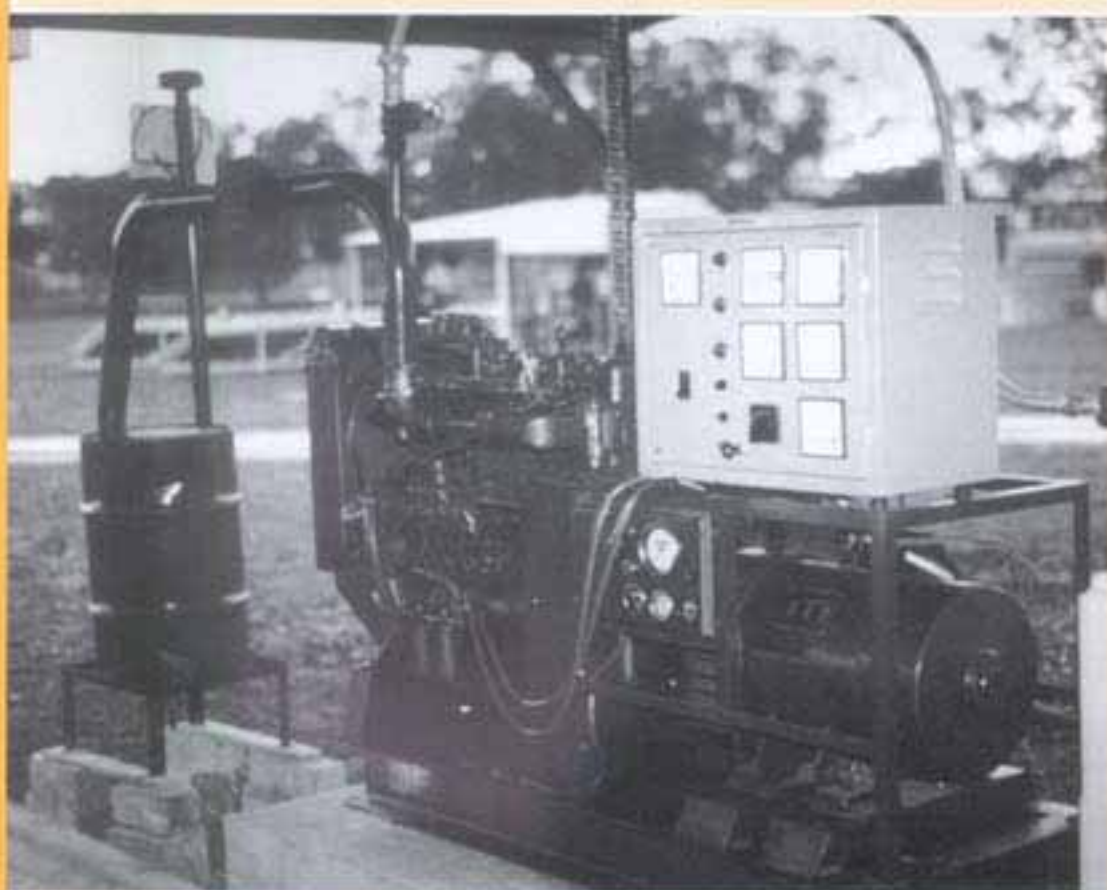

FOOD
AND
AGRICULTURE
ORGANIZATION
OF THE
UNITED NATIONS

Wood gas as engine fuel

Mechanical Wood Products Branch
Forest Industries Division
FAO Forestry Department

The designations employed and the presentation of material in this publication do not imply the expression of any opinion whatsoever on the part of the Food and Agriculture Organization of the United Nations concerning the legal status of any country, territory, city or area or of its authorities, or concerning the delimitation of its frontiers or boundaries.

M-38
ISBN 92-5-102436-7

All rights reserved. No part of this publication may be reproduced, stored in a retrieval system, or transmitted in any form or by any means, electronic, mechanical, photocopying or otherwise, without the prior permission of the copyright owner. Applications for such permission, with a statement of the purpose and extent of the reproduction, should be addressed to the Director, Publications Division, Food and Agriculture Organization of the United Nations, Via delle Terme di Caracalla, 00100 Rome, Italy.

© FAO 1986

This electronic document has been scanned using optical character recognition (OCR) software and careful manual recorection. Even if the quality of digitalisation is high, the FAO declines all responsibility for any discrepancies that may exist between the present document and its original printed version.

Table of Contents

Preface

Chapter 1 - Introduction

1.1 Background

1.2 The present case for wood gasifiers

1.3 Overview of the contents of this publication

1.4 What to expect from a wood gasifier system

Chapter 2 - Small wood and charcoal gasifiers for operation of internal combustion engines

2.1 Fuelling of engines by producer gas

- 2.1.1 Possibilities of using producer gas with different types of engines
- 2.1.2 Engine power output using producer gas
- 2.1.3 Maximizing the power output in producer-gas operation
- 2.1.4 Resulting power output
- 2.1.5 Gas quality requirements for trouble-free operation
- 2.1.6 Use of Stirling engines or gas turbines with producer gas

2.2 Theory of gasification

- 2.2.1 Prediction of the gas composition
- 2.2.2 Gasifier efficiency

2.3 Types of gasifiers

- 2.3.1 Updraught or counter current gasifier
- 2.3.2 Downdraught or co-current gasifiers
- 2.3.3. Cross-draught gasifier
- 2.3.4. Fluidized bed gasifier
- 2.3.5 Other types of gasifiers

2.4 Gasification fuels

- 2.4.1 Need for selection of the right gasifier for each fuel
- 2.4.2 Energy content of the fuel
- 2.4.3 Moisture content of the fuel
- 2.4.4 Volatile matter content of the fuel
- 2.4.5 Ash content and ash chemical composition
- 2.4.6 Reactivity of the fuel
- 2.4.7 Particle size and size distribution
- 2.4.8 Bulk density of the fuel
- 2.4.9 Charring properties of the fuel
- 2.4.10 Assessment of the suitability of various types of biomass as gasifier fuel

2.5 Design of downdraught gasifiers

- 2.5.1 Processes occurring in the down-draught gasifier
- 2.5.2 Design guidelines for downdraught gasifiers

2.6 Gas cleaning and cooling

- 2.6.1 Cleaning dust from the gas
- 2.6.2 Gas cooling

2.7 Applications of biomass gasification

- 2.7.1 Production of fuel gas
- 2.7.2 Production of mechanical or electrical power in stationary installations
- 2.7.3 Mobile applications

2.8 Health and environmental hazards associated with the use of producer gas

- 2.8.1 Toxic hazards
- 2.8.2 Fire hazards
- 2.8.3 Explosion hazards
- 2.8.4 Environmental hazards

Chapter 3 - Recent Swedish experiences with operation of vehicles on wood and charcoal gas

3.1 Overview of development work and testing carried out at the national machinery testing institute

- 3.1.1 Scope of the work
- 3.1.2 Gasifier for wood chips
- 3.1.3 Fibre glass fabric filter system
- 3.1.4 Conversion of diesel engines to producer gas operation
- 3.1.5 Tests with different fuels

3.2 Experiences gained from conversion and operation of modern vehicles

- 3.2.1 The need for continued practical tests
- 3.2.2 Conversion and operation of a Massey Ferguson 1100 farm tractor
- 3.2.3 Conversion and operation of a Scania truck
- 3.2.4 Experiences related to service, maintenance and equipment failures

3.3 Producer gas vehicles recently operated in other countries

3.4 Economic evaluation of operation of vehicles on wood gas

- 3.4.1 The case for wood gasifiers
- 3.4.2 Method used for the economic evaluation
- 3.4.3 Economic baseline assumptions
- 3.4.4 Marginal costs for the wood gasifier system
- 3.4.5 Economy of a producer gas tractor
- 3.4.6 Economy of a producer gas truck

3.5 Feasibility of using the vehicle gasifier technology for stationary applications

3.6 Operating hazards

Chapter 4 - A small wood gas power plant at a sawmill in Paraguay

4.1 Description of the wood gas power plant

- 4.1.1 Fuel supply
- 4.1.2 The wood gasifier
- 4.1.3 Wood gas cooling and washing installations
- 4.1.4 Wood gas filter
- 4.1.5 Engine and electric generator

4.2 Operating experience

- 4.2.1 Fuel consumption
- 4.2.2 Manpower employed and operating procedure
- 4.2.3 Safety
- 4.2.4 Environmental impact

4.3 Economic evaluation

- 4.3.1 Capital investment
- 4.3.2 Operation and maintenance costs
- 4.3.3 Fuel costs
- 4.3.4 Total operating costs
- 4.3.5 Costs for electricity generation for family homes of sawmill personnel
- 4.3.6 Comparison with other alternatives for the electricity supply

Chapter 5 - A small gasifier power plant in Sri Lanka

5.1 Description of the plant

- 5.1.1 General system layout
- 5.1.2 The gasifier
- 5.1.3 Cyclone
- 5.1.4 Impingement separator
- 5.1.5 Glass fibre cloth filter
- 5.1.6 Cooler
- 5.1.7 Engine and alternator
- 5.1.8 Start-up fan and flare
- 5.1.9 Safety devices
- 5.1.10 Auxiliaries

5.2 Operational procedures

- 5.2.1 Start-up
- 5.2.2 Closing down
- 5.2.3 System maintenance

5.3 Operational experience

- 5.3.1 Operating record and observations on the performance
- 5.3.2 Disturbances of the operation
- 5.3.3 Desirable modifications

5.4 Economic evaluation of electricity generation costs at Giriulla mill

5.5 Concluding remarks

Chapter 6 - A 1.4 MW wood gas fuelled power plant in Paraguay

- 6.1 Historical background of the gasifier installations**
- 6.2 Wood-fuel supply and preparation**
- 6.3 Description of the down-draught gasifiers**
- 6.4 Electricity production with the gas engine alternator sets**
- 6.5 Operating experiences**
- 6.6 Profitability of using wood gas at Loma Plata**

Chapter 7 - The future of wood gas as engine fuel

7.1 Prerequisites for extensive use of wood gasifiers

7.2 Industrialized countries

7.3 Developing countries

7.4 The need for international cooperation

Appendix 1 - Calculation of the power output of a producer gas engine

Appendix 2 - Design calculation of downdraught gasifier

Table of conversion factors and symbols (used in this manual)

References

Preface

Wood gasifiers played an important role in the past in the substitution of oil-based fuels in internal combustion engines, but fell into disuse after the Second World War because of their economic and technical disadvantages as compared with relatively inexpensive imported fuels.

Since the middle of the 1970's the increase in oil prices has led to a renewed interest in wood gasification technology, especially in countries dependent on oil imports but with adequate supplies of wood or other biomass fuels or, as in the case of Sweden, where the technology is maintained and developed as a matter of policy.

Research into the technology of gasifier/engine systems has provided modern designs which work reliably at a level of technical skill appropriate to rural applications in developing countries. Such systems are economic in certain conditions found in many developing countries, but the technology and manufacturing facilities are not widely available and their commercial utilisation is limited.

In "Wood Gas as Engine Fuel" FAO presents a summary of modern wood gasification technology and the economics of its application to internal combustion engines. Texts on different aspects of wood gasification, prepared by specialists, are the basis of this publication.

FAO gratefully acknowledges the co-operation of B. Kjellström of the Beijer Institute, Stockholm; H. Stassen of the Twente University of Technology, Enschede, Netherlands; D. de Silva of the Ceylong Institute of Scientific and Industrial Research; N.E. Cañete of the Sociedad Cooperativa Chortitzer Komitee, Paraguay and R. Thun of the Technical Research Centre of Finland.

1.1 Background

Coal, wood and charcoal gasifiers have been used for operation of internal combustion engines in various applications since the beginning of this century. The utilization peaked during the Second World War when almost a million gasifiers were used all over the world, mainly vehicles operating on domestic solid fuels instead of gasoline.

It is important to keep in mind that small gasifiers have been used quite extensively in the past and that they have played a very important part in reducing or eliminating the need for fuel imports in some countries. There is no need, however, in this publication to go deeper into the history of the development of small gasifier technology. Those who are interested in the subject are advised to study the reviews made by the Swedish Academy of Engineering Sciences (43) Kaupp and Goss (20) Skov (36) Bailey (3) Earthscan (12) or the National Academy of Sciences in U.S.A. (32).

Interest in the technology of gasification has shown a number of ups and downs over the last eighty years, as is strikingly illustrated in Fig. 1.1 which reproduces a histogram that plots the number of wood gasification reports referred to in "Chemical Abstracts" since the year 1900.

It appears that interest in gasification research correlates closely with the relative cost and availability of liquid and gaseous fossil fuels. The histogram shows that the number of articles was at an all-time peak in 1979, following a period of low activity in the 1950's and 1960's.

There is an important difference between the earlier periods of high interest and the present situation, however. Earlier, the increase in scientific activity corresponded to an increased number of gasifiers in practical use. The recent increase in scientific interest has not yet resulted in much practical and commercial activity. The reason will be discussed in the last chapter of this publication.

1.2 The present case for wood gasifiers

After the double fuel crises of 1973 and 1979, the harmful effect of high and rising oil prices on the economies and development efforts of oil-importing developing countries have become apparent. There has, as a result been increased interest in indigenous, renewable energy sources, of which biomass in the form of wood or agricultural residues is the most readily available in many developing countries.

Figure 1.1 Wood gasification citations in Chemical Abstracts

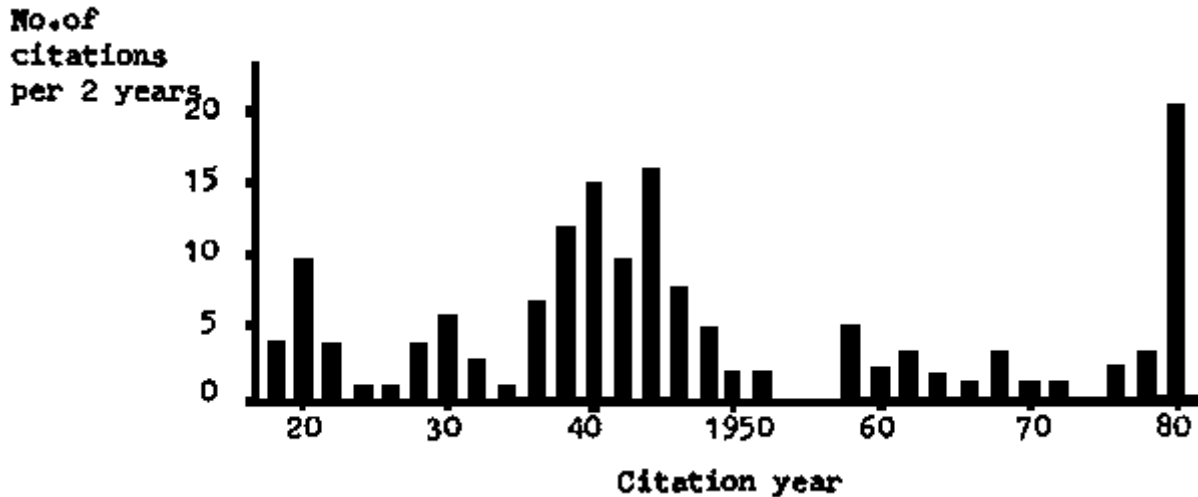

A characteristic of the energy system in many developing countries - in particular in rural areas - is that internal combustion engines are widely used in stationary applications such as electric power generation and operation of water pumps and mills. Technologies such as gasification, which allow utilization of biomass fuel in such engines after minimum preparation, are therefore of particular importance.

In industrialized countries internal combustion engines are mainly used for vehicles. Electricity generated in large central power stations is used for most of the stationary applications.

These different structures of energy systems explain why there appears to be fairly small interest in using biomass gasifiers for operation of internal combustion engines in the industrialized world, whereas several developing countries are either introducing small biomass gasifiers or are in the process of evaluating the technology.

Charcoal gasifiers dominate the present re-introduction of small gasifiers for engine operation in developing countries. They are the basis of the systems used in the Philippine programme and in Brazil, see (5). Much of the indigenous research and development now carried out in developing countries is also concentrated on charcoal gasifiers in view of their good prospects for early commercialization.

As illustrated by Figure 1.2, the utilization of charcoal gasifiers does, however, imply higher demands on the biomass resources, resources which are indeed already over-exploited in many developing countries. On the other hand, at least some designs of charcoal gasifiers are less likely to cause operational trouble than wood gasifiers or gasifiers for agricultural residues. This is because one of the potential problems with the latter, the excessive tar content in the gas, is virtually eliminated by the removal of most of the volatiles in the production process for charcoal.

Experience from the Second World War shows, however, that properly designed wood gasifiers, operated within their design range and using fuels within the fuel specifications (which may differ between designs), can provide a sufficiently tar free gas for trouble-free operation.

One of the objectives of this publication is to make decision-makers more aware of the possibilities of using wood gasification as a substitute for gasoline and diesel oil, without unreasonable increase of the demand on the natural resource.

1.3 Overview of the contents of this publication

In this publication, an overview of gasifies technology and the main design rules for downdraught wood gasifiers are presented together with some accounts of recent experiences from practical operation, and assessments of the economy of the technique.

The possibilities of fuelling different types of engines by producer gas, the theory of wood gasification, gasification fuels, gasifier types and their design rules are presented in chapter 2. This chapter should not be considered as a complete design handbook for downdraught wood gasifies systems, but as a guide to those who wish to be able to assess the suitability of a particular gasifier system for a particular engine. Health and environmental hazards associated with the use of producer gas are also outlined.

Figure 1.2 Comparison between the amounts of gasoline which can be substituted by producer gas if wood or charcoal is utilized in the gasifier

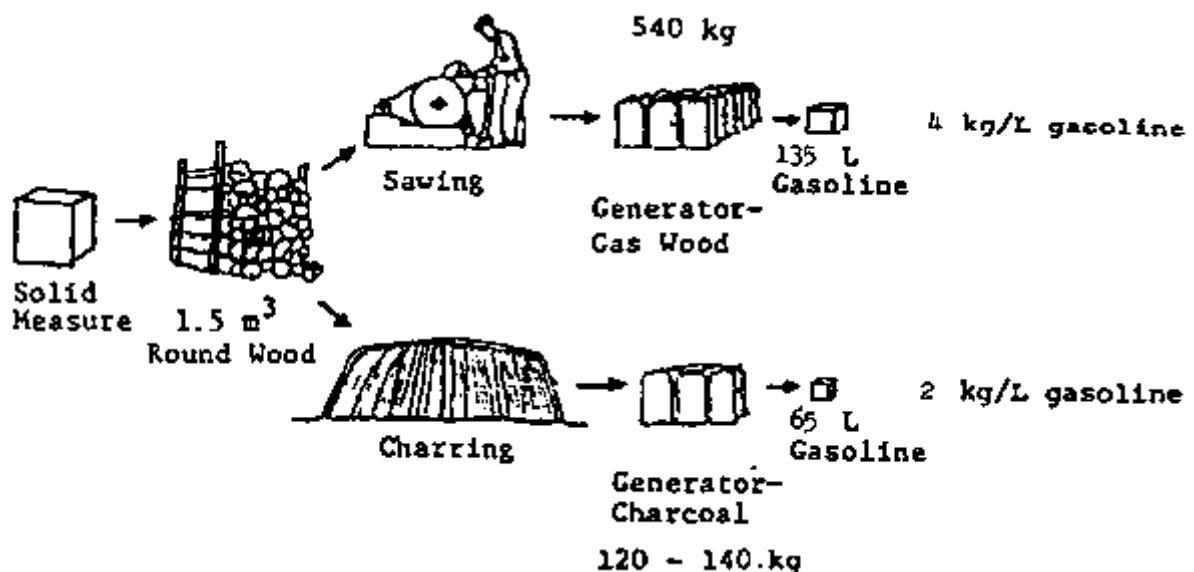

The economy of using wood gasifiers for different stationary applications is discussed in chapters 4 to 6. These chapters also include accounts of recent operating experiences.

Use of gasifiers for operation of modern vehicles is discussed in chapter 3, on the basis of recent Swedish experiences. This chapter is designed to assist in evaluating the feasibility of wood gasifiers for road vehicles or tractors.

Even if the results presented in chapters 3 to 6 are valid in the strict sense, only for the particular circumstances of the cases described, they should be useful as indications of what

can be expected in similar situations. The information can be adapted for applications where the operating conditions or the economic circumstances are different.

The future of wood gas as engine fuel is discussed in the final chapter where the need for continued international cooperation in this field is also emphasized.

1.4 What to expect from a wood gasifier system

Operation of modern spark ignition or compression ignition stationary engines with gasoline or diesel fuel is generally characterized by high reliability and minor efforts from the operator. Under normal circumstances the operator's role is limited to refuelling and maintenance. There is little need for action and virtually no risk of getting dirty. Start and operation can in fact be made fully automatic.

Anybody expecting something similar for wood gas operation of engines will be disappointed. Preparation of the system for starting can require half an hour or more. The fuel is bulky and difficult to handle. Frequent feeding of fuel is often required and this limits the time the engine can run unattended. Taking care of residues such as ashes, soot and tarry condensates is time-consuming and dirty.

It is a common mistake to assume that any type of biomass which fits into the opening of the refuelling lid can be used as fuel. Many of the operational difficulties which face inexperienced users of gasifiers are caused by the use of unsuitable fuels. In order to avoid bridging in the fuel bunker, reduced power output because of large pressure losses, or "weak" gas, slag cakes, tar in the engine and damage to the gasifier caused by overheating, it is necessary for most designs that the fuel properties are kept within fairly narrow ranges. This is not necessarily a more serious limitation than the need to use gasoline of super grade for high compression spark ignition engines rather than regular gasoline or diesel fuel. But in the case of gasifier operation, more of the responsibility for quality control of the fuel rests with the operator. The need for strict fuel specifications is well documented in the experiences reported from the Second World War (43). It is unfortunate that some commercial companies, with little practical experience, but trying to profit from the renewed interest in gasification, have advertised the possibility of using almost any kind of biomass even in gasifiers which will work well only with fuels meeting fairly strict standards. This has in some cases created unrealistic expectations and has led to disappointments with the technology.

Operation of wood gas engines can also be dangerous if the operator violates the safety rules or neglects the maintenance of the system. Poisoning accidents, explosions and fires have been caused by unsafe designs or careless handling of the equipment. It may be assumed that modern systems are designed according to the best safety standards, but it is still necessary to handle the equipment in a responsible manner.

Finally, it must be realised that the current technology is generally based on the designs of the mid-1940's. Only a few persons have retained detailed practical knowledge of design, material selection and operation and maintenance procedures. Many of the currently active manufacturers have no access to the experience of such persons and base their designs on information available in the literature, and on recent and comparatively limited experience. There has been some improvement of the technology, for instance of filter designs based on new materials, but the practical operating experience with these improved systems is limited. A consequence of this is that equipment failures caused by design mistakes, choice of the wrong materials, or incomplete instructions to the user on operation and maintenance, must be expected in the first period of reintroduction of wood gasifiers.

The reports on operational difficulties presented in this publication and elsewhere must be evaluated with this in mind. It can safely be assumed that second generation systems will show improved performance.

Those interested in the technology must accept that it demands hard work and tolerance of soiled hands by a responsible operator, and that it is not yet perfect. But as will be shown, it is both serviceable and economic in many applications in spite of its inconveniences.

Chapter 2 - Small wood and charcoal gasifiers for operation of internal combustion engines

The gasification of coal and carbon containing fuels and the use of the gas as fuel in internal combustion engines is a technology which has been utilized for more than a century.

There has recently been renewed interest in this technology, mainly as a means to utilize biomass fuels instead of imported petroleum fuels in developing countries. This interest derives from the documented evidence that, during the Second World War, more than a million vehicles buses, trucks, motorcars, boats and trains - were powered by gasifiers fuelled by wood, charcoal, peat or coal. After the war, nevertheless, there was a complete reversion to liquid fuels as soon as these again became available, obviously because of their convenience, reliability and economic advantages.

Therefore, the impact of biomass gasification on the energy supply systems of developing countries seems to hinge on the answer to one central question: has modern technology and gasifier development led to improved gasifier designs and gasification systems, that can work reliably, efficiently, economically and at a suitable technical level where special skills may be lacking?

In order to answer this question it is necessary to review a number of aspects of the gasification technology. The type of system considered is schematically illustrated in Figure 2.1.

The internal combustion engine uses as fuel gas generated by gasification of vegetable matter with-air. The gas is cleaned and cooled before entering the engine. In Fig. 2.1 the engine is shown driving an electric generator, but it may of course be utilized for any other purpose where such engines are employed.

The possibilities of using different types of engines with producer gas, and the quality of gas needed, will first be reviewed in order to provide the necessary background for an understanding of the effects on gasifier system design.

The theory of gasification, different type of gasifiers and gasified fuels will then be discussed and design guidelines for down-draught gasifiers will be presented. Techniques of gas cleaning and cooling will then be examined. The chapter concludes with a discussion of possible applications, and the hazards and environmental consequences associated with this technology.

From the treatment of these subjects it will become clear that severe constraints still exist to the introduction of gasification systems. However, it will be shown that, within the current state-of-the-art of gasification technology, several technically and economically sound possibilities exist.

In order to assist users and designers of gasification equipment, examples of the power output of an internal combustion engine fuelled by producer gas are given in Appendix I; and the design of a simple downdraught gasification unit, fuelled by wood blocks, is presented in Appendix II.

Figure 2.1 Scheme of a producer gas power plant

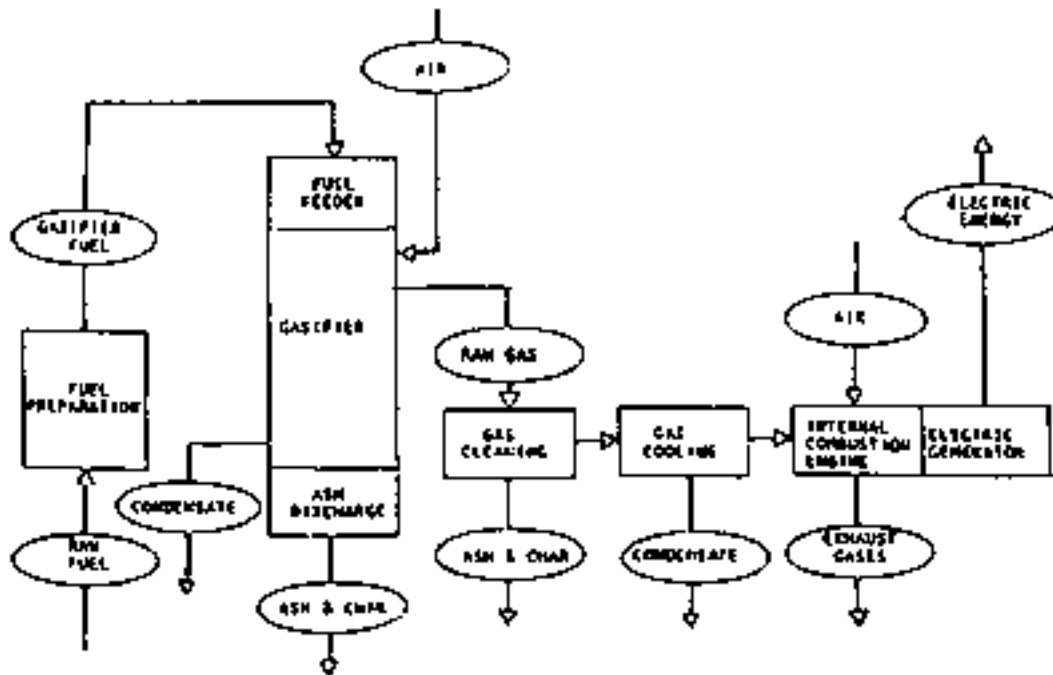

2.1 Fuelling of engines by producer gas

Producer gas, the gas generated when wood, charcoal or coal is gasified with air, consists of some 40 per cent combustible gases, mainly carbon monoxide, hydrogen and some methane. The rest are non-combustible and consists mainly of nitrogen, carbon dioxide and water vapour.

The gas also contains condensable tar, acids and dust. These impurities may lead to operational problems and abnormal engine wear. The main problem of gasifier system design is to generate a gas with a high proportion of combustible components and a minimum of impurities. How this can be achieved will be shown later. First, the peculiarities of producer gas engines will be discussed both from a theoretical and operational point of view.

2.1.1 Possibilities of using producer gas with different types of engines

Spark ignition engines, normally used with petrol-or kerosene, can be run on producer gas alone. Diesel engines can be converted to full producer gas operation by lowering the compression ratio and the installation of a spark ignition system. Another possibility is to run a normal unconverted diesel engine in a "dual fuel" mode, whereby the engine draws anything between 0 and 90 per cent of its power output from producer gas (17), the remaining diesel oil being necessary for ignition of the combustible gas/air mixture. The advantage of the latter system lies in its flexibility: in case of malfunctioning of the gasifier or lack of biomass fuel, an immediate change to full diesel operation is generally possible.

However, not all types of diesel engines can be converted to the above mode of operation. Compression ratios of ante-chamber and turbulence chamber diesel engines are too high for satisfactory dual fuel operation and use of producer gas in those engines leads to knocking caused by too high pressures combined with delayed ignition (20). Direct injection diesel engines have lower compression ratios and can generally be successfully converted.

2.1.2 Engine power output using producer gas

The power output from an engine operating on producer gas will be determined by the same factors as for engines operating on liquid fuels, namely:

- the heating value of the combustible mixture of fuel and air which enters the engine during each combustion stroke;
- the amount of combustible mixture which enters the engine during each combustion stroke;
- the efficiency with which the engine converts the thermal of the combustible mixture into mechanical energy (shaft power);
- the number of combustion strokes in a given time (number of revolutions per minute: rpm);

Conversion of an engine to producer gas or dual-fuel operation will generally lead to a reduced power output. The reasons for this and possibilities to minimize the power loss will be discussed below.

(a) Heating value of the mixture

The heating value of producer gas depends on the relative amounts of the different combustible components: carbon monoxide, hydrogen and methane.

The heating value of these three gases are given in Table 2.1.

Table 2.1. Heating values and stoichiometric oxygen demands of combustible producer gas components.

Gas	Eff. Heating kJ/mol	value kJ/m ³ / 1/	Stoichiometric Oxygen demand (m ³ /m ³)
carbon monoxide	283660	12655	0.5
hydrogen	241300	10770	0.5
methane	801505	35825	2.0

1/ The gas volume is given as normal - m, unless otherwise specified, throughout the publication.

In order to achieve combustion however, the producer gas has to be mixed with a suitable amount of air. The combustible mixture will have a lower heating value per unit volume than producer gas alone.

The amounts of oxygen necessary for complete burning (stoichiometric combustion) of each of the combustible components are also presented in Table 2.1.

The heating value of such a stoichiometric mixture can be calculated from the following formula:

$$H_{ig} = \frac{12680 V_{CO} + 10800 V_{H_2} + 35900 V_{CH_4}}{1 + 2.38 V_{CO} + 2.38 V_{H_2} + 9.52 V_{CH_4}}$$

where:

H_{ig} - is the heating value of a stoichiometric mixture of producer gas and air in kJ/m^3

V_{CO} - volume fraction of carbon monoxide in the gas (before mixing with air)

V_{H_2} - volume fraction of hydrogen in the gas (before mixing with air)

V_{CH_4} - volume fraction of methane in the gas (before 4 mixing with air).

Heating values of producer gas and air mixtures are around 2500 kJ/m^3 . When this value is compared with the heating value of a stoichiometric mixture of petrol and air (about 3800 kJ/m^3), the difference in power output between a given engine fuelled by petrol and by producer gas becomes apparent. A power loss of about 35% can be expected as a result of the lower heating value of a producer gas/air mixture.

(b) Amount of combustible mixture supplied to the cylinder

The amount of combustible mixture which actually enters the cylinder of an engine is determined by the cylinder volume and the pressure of the gas in the cylinder at the moment the inlet valve closes.

The cylinder volume is a constant for a given engine. The actual pressure of the combustible mixture at the start of the compression stroke depends however on engine characteristics (especially the design of inlet manifold and air inlet gate), the speed of the engine (higher speeds tend to result in lower pressures), and on the pressure of the gas entering the air inlet manifold. The former two factors are incorporated in the so called "volumetric efficiency" of the engine, which is defined as the ratio between the actual pressure of the gas in the cylinder and normal pressure (1 atm). Normally engines running at design speeds show volumetric efficiencies varying between 0.7 and 0.9.

The pressure of the gas at the air inlet manifold depends on the pressure drop over the total gasification system, i.e. gasifier cooler/cleaner, and gas/air carburettor. This drop reduces again the entering pressure by a factor of 0.9.

In sum, it must be concluded that the actual amount of combustible gas available in the cylinder will be only 0.65 - 0.8 times the theoretical maximum because of pressure losses on the way to the cylinder. This will obviously reduce the maximum power output of the engine.

(c) Engine efficiency

The efficiency with which an engine can convert the thermal energy in the fuel into mechanical (shaft) power, depends in the first instance on the compression ratio of the engine.

The influence of increasing the compression ratio of an engine can be calculated from the following formula.

$$\eta_1 - \eta_0 = \epsilon_1^{1-k} - \epsilon_0^{1-k}$$

In which:

η_1 = engine thermal efficiency at compression ratio
 η_0 = engine thermal efficiency at compression ratio
 ε_1 = engine compression ratio in situation 1
 ε_0 = engine compression ratio in situation 0
 k = a constant equal to 1.3 in the case of producer gas

Figure 2.2 Relation between compression ratio and thermal efficiency of an engine (7)

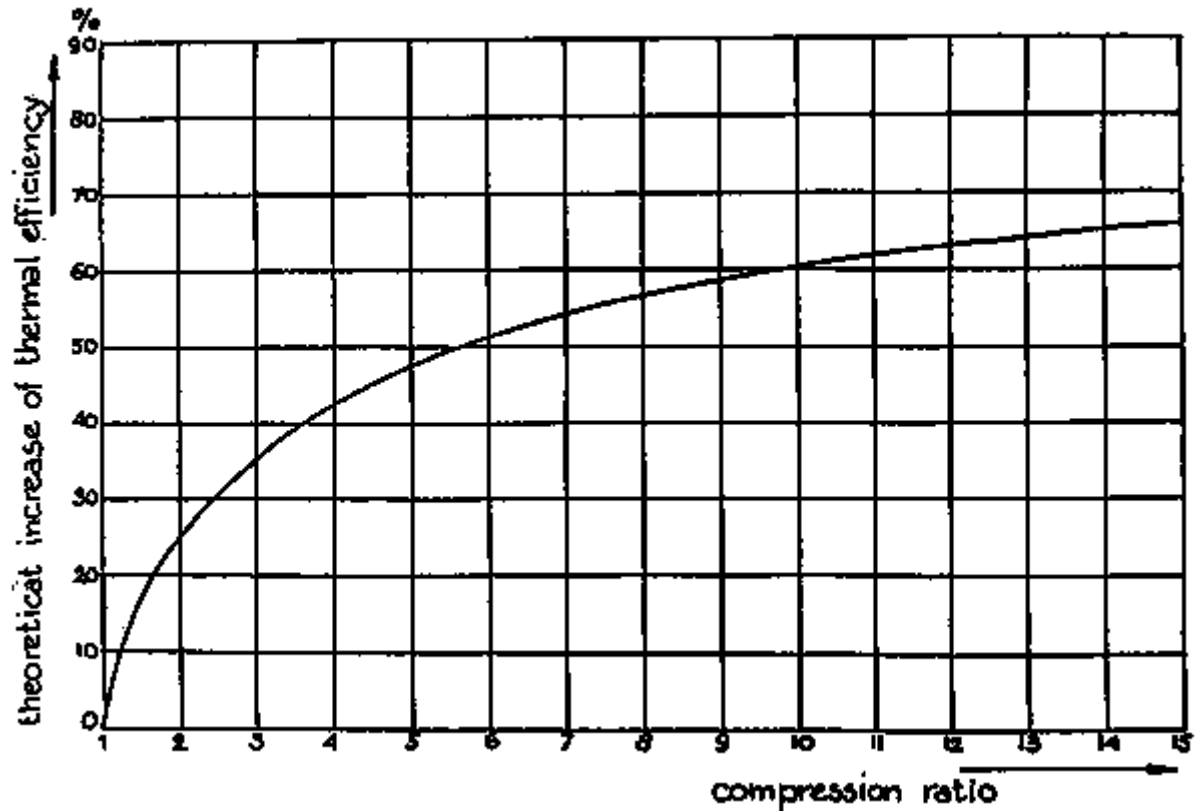
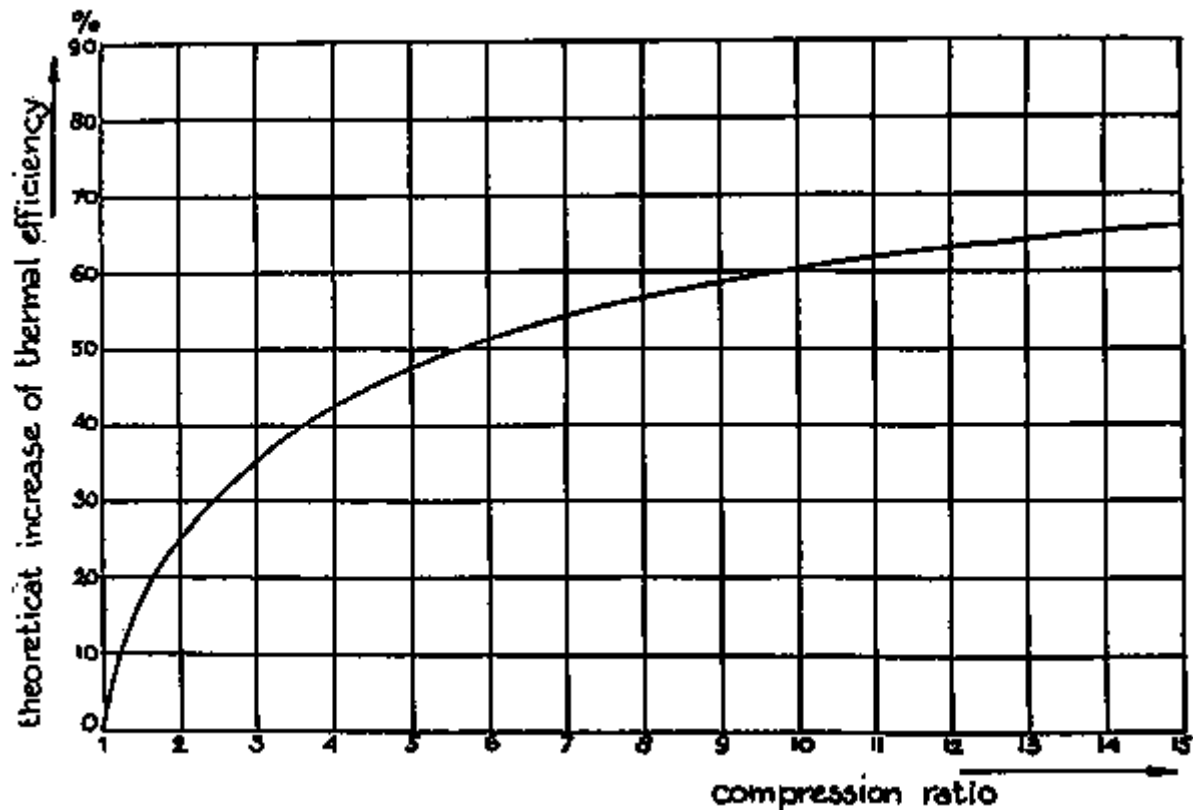

Figure 2.2 shows the influence of compression ratio on maximum engine power output.

Figure 2.2 Relation between compression ratio and thermal efficiency of an engine (34)



In the case of engines fuelled by petrol, the possible compression ratio is limited by the "octane" number of the fuel, which is a measure of the compression ratio at which detonation or "knocking" (which can lead to severe engine damage) occurs. Producer gas/air mixtures show higher octane numbers than petrol/air mixtures.

It is for this reason that higher compression ratios (up to 1:11) can be employed with producer gas, resulting in better engine thermal efficiencies and a relative increase in engine shaft power output.

(d) Engine speed

Because the engine power output is defined per unit time, the engine power output depends on the engine speed.

For diesel engines the power output is nearly linear with the rpm. For spark ignition engines the power increase is less than linear because of changes in the different efficiency factors.

When the power output of a 4-stroke engine is calculated, allowance must be made for the fact that only one out of every two rotations represents a compression and combustion stroke.

The maximum speed of engines fuelled by producer gas is limited by the combustion velocity of the combustible mixture of producer gas and air. Because this speed is low as compared to combustible mixtures of petrol and air, the efficiency of the engine can drop dramatically if the combustion speed of the mixture and the average speed of the piston become of the same order of magnitude.

In the types of engines that are currently mass-produced, one can expect this phenomenon to occur at engine speeds of around 2500 rpm. Engines fuelled by producer gas should therefore generally be operated below this speed.

2.1.3 Maximizing the power output in producer-gas operation

The possibilities of maximizing the power output are generally related to the theoretical causes of power loss discussed in the preceding section. They will be treated in the same order here.

(a) Heating value of the mixture

It is evident that the highest heating values for the combustible mixture are achieved at the highest heating value of the producer gas itself. As will be explained later, the heating value depends on the design of the gasifier and on the characteristics of the fuel provided to the gasifier. Minimization of the heat losses from the gasifier is important in order to achieve a high heating value of the gas. The moisture content and the size distribution are two of the most important fuel characteristics.

In mixing the producer gas with combustion air there is an additional reason for power loss because of changes in the composition of the gas, as well as of variations in pressure drop over the gasifier installation and it is very difficult to maintain continuously a stoichiometric mixture of producer gas and air.

Because both excess and deficiency of air lead to a decrease in the heating value of the mixture (per unit volume), both will lead to a decrease in power output as illustrated in figure 2.3.

Figure 2.3 Decrease of the heating value of a producer gas/air mixture as a function of air deficiency or excess (34)

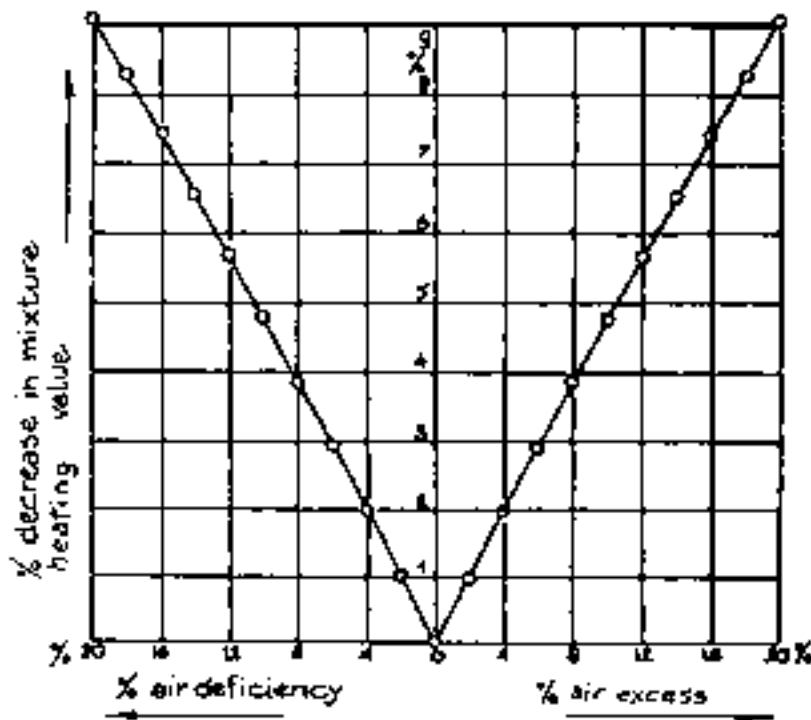

The only feasible way to adjust the mixture to its stoichiometric combustion is by installing a hand operated valve on the combustion air inlet of the engine and operating this regularly for maximum engine power output.

If maximum engine power output is not needed, it is usually better to operate the engine with a slight excess of air, in order to prevent backfiring in the engine exhaust gas system.

(b) Amount of combustible mixture

Apart from minimizing the pressure drop over the gasifier, cooling and cleaning system and carburettor (while still maintaining adequate gas/air mixing as discussed above) the amount of combustible mixture per engine combustion stroke can be maximized in two ways:

- increasing the volumetric efficiency of the engine by introducing a wider air inlet manifold resulting in less gas flow resistance and smaller pressure drops. The influence of a well designed air inlet manifold is often underestimated. Experiments by Finkbeiner (11) show that a well designed air inlet manifold can increase maximum engine power output by 25 per cent.

- supercharging or turbo charging the engine. From the remarks made earlier, it will be clear that increasing mixture pressure at the engine inlet will increase the engine's maximum power output. The recent development of turbo-chargers driven by the exhaust gases of the engine makes this option attractive. However care should be taken to water-cool the turbo charger in order to prevent explosions of the combustible mixture.

(c) Engine efficiency

The increase in engine efficiency that can be reached by increasing the compression ratio of petrol-engines (for example to 1:10 or 1:11) has been discussed earlier. Gas engines have standard compression ratios in this range and for this reason are especially suited to producer gas operation.

The influence of correct air/gas mixing has been described by Finkbeiner (11) and has recently been studied by Tiedema and van der Weide (42). Installation of suitable gas/air mixing devices (such as the type of carburettor developed by TNO, (the Dutch parastatal research organisation) can lead to an increase in maximum engine power output of 10-15 percent as compared to the usual two-valve pipe and chamber type carburettors.

(d) Engine speed and ignition advance

Because of the slow combustion speed of the gas/air mixture the timing of the ignition in producer gas fuelled petrol engines must generally be changed.

The optimal timing of the ignition in petrol engines depends on the load and the engine speed. This is also the case in producer gas operation. Experiments by Middleton and Bruce (29) indicate that, in general, ignition timing should be advanced by 10° - 15°, leading to ignition advances of 35° - 40° before top-dead-centre (TDC).

If a diesel engine is operated in a dual fuel mode, it is also advantageous to advance the timing of the diesel fuel injection. Again the necessary advance depends on the engine speed, as shown by Nordstrom (33), Tiedema e al. (42) report good results with injection timing advances of 10° as compared to full diesel operation.

A problem sometimes encountered in dual fuelled engines is detonation. Apart from engines with too high compression ratios (above 1:16), this phenomenon mostly occurs when an attempt is made to remedy low power output of the engine by introducing increased amounts of diesel fuel. Depending on the composition of the producer gas and on the mixture strength of the fuel, an excess of pilot fuel can lead to detonation. For this reason the amount of pilot diesel fuel, in dual fuel operation, must have an upper limit. Generally a limitation at around 30 percent of maximum engine power output will prevent detonation.

The amount of pilot diesel fuel in dual fuel operation also has a lower limit. Depending on the engine speed (30) a certain minimum amount of diesel fuel per cycle has to be injected in order to ensure ignition. The minimum amounts vary from 3-5 mm³ per cycle.

In practical operation however a somewhat higher amount of diesel fuel is injected per cycle in order to stay on the safe side. Diesel fuel injections of 8-9 mm³ per cycle and cylinder is recommended.

2.1.4 Resulting power output

Assuming that the engine modifications described above are correctly implemented, decrease in maximum power output of petrol engines without turbo or supercharging can be limited to about 30 percent. Turbo or supercharged combustion running engines on producer gas can have power outputs equal to those in petrol operation.

Derating of direct injection diesel engines in dual fuel operation can usually be limited to 15 - 20 percent (80 percent producer gas, 20 percent diesel fuel).

2.1.5 Gas quality requirements for trouble-free operation

When a gasifier system is used in conjunction with an internal combustion engine, an important requirement is that the engine is supplied with a gas that is sufficiently free from dust, tars and acids. The tolerable amounts of these substances will vary depending on the type and outfit of the engine. Tiedema and van der Weide (38) give as tolerable average amounts for currently available engines the following values:

dust: lower than 50 mg/m³ gas preferably 5 mg/m³ gas
tars: lower than 500 mg/m³ gas
acids: lower than 50 mg/m³ gas (measured as acetic acid).

2.1.6 Use of Stirling engines or gas turbines with producer gas

In addition to the use of producer gas with internal combustion engines, other possibilities are the combination of gasifiers with gas turbines or with Stirling engines. Because high inlet gas temperatures aid the thermal efficiency of gas turbines, these in principle present an attractive option for converting hot producer gas into mechanical and/or electric power. However, the current state-of-art of gasifier as well as turbine technology prevents their use. Gas turbines are very sensitive to dust, especially at high inlet temperatures, and it is doubtful if gas quality requirements can be met with the filtering systems described in section 2.6.

Another problem stems from the sensitivity of current turbine vanes to corrosion by alkaline vapours (Na, K and Ca) which are usually present in tiny amounts in producer gas. An

optimum system would require a pressurised gasifier, which would add considerably to cost and complexity and probably will only be economic for very large installations.

Beagle (6) mentions the possibility of using Stirling engines in conjunction with gasifiers especially in micro scale applications. Stirling engines in this power range are now becoming commercially available.

Because of a number of advantages as compared to the use of internal combustion engines (low maintenance, high efficiency, low lubricant consumption etc.) this concept should be further evaluated and tested.

2.2 Theory of gasification

The substance of a solid fuel is usually composed of the elements carbon, hydrogen and oxygen. In addition there may be nitrogen and sulphur, but since these are present only in small quantities they will be disregarded in the following discussion.

In the types of gasifiers considered here, the solid fuel is heated by combustion of a part of the fuel. The combustion gases are then reduced by being passed through a bed of fuel at high temperature.

In complete combustion, carbon dioxide is obtained from the carbon and water from the hydrogen. Oxygen from the fuel will of course be incorporated in the combustion products, thereby decreasing the amount of combustion air needed.

Oxidation, or combustion, is described by the following chemical reaction formulae:

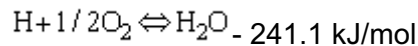
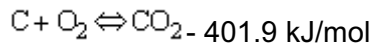

These formulae mean that burning 1 gram atom, i.e. 12.00 g of carbon, to dioxide, a heat quantity of 401.9 kJ is released, and that a heat quantity of 241.1 kJ results from the oxidation of 1 gram molecule, i.e. 2.016 g of hydrogen to water vapour.

In all types of gasifiers, the carbon dioxide (CO₂) and water vapour (H₂O) are converted (reduced) as much as possible to carbon monoxide, hydrogen and methane, which are the main combustible components of producer gas.

The most important reactions that take place in the reduction zone of a gasifier between the different gaseous and solid reactants are given below. A minus sign indicates that heat is generated in the reaction, a positive sign that the reaction requires heat.

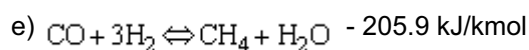
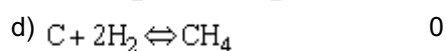
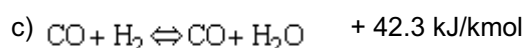
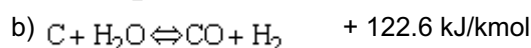

Equations (a) and (b), which are the main reactions of reduction, show that reduction requires heat. Therefore the gas temperature will decrease during reduction.

Reaction (c) describes the so-called water-gas equilibrium. For each temperature, in theory, the ratio between the product of the concentration of carbon monoxide (CO) and water vapour (H₂O) and the product of the concentrations of carbon dioxide (CO₂) and hydrogen (H₂) is fixed by the value of the water gas equilibrium constant (K_{WE}). In practice, the equilibrium composition of the gas will only be reached in cases where the reaction rate and the time for reaction are sufficient.

The reaction rate decreases with falling temperature. In the case of the water-gas equilibrium, the reaction rate becomes so low below 700°C that the equilibrium is said to be "frozen". The gas composition then remains unchanged. Values of K_{WE} for different temperatures are given in Table 2.2.

$$K_{WE} = \frac{(CO) \times (H_2O)}{(CO_2) \times (H_2)}$$

Table 2.2 Temperature dependence of the water-gas equilibrium constant.

Temperature (°C)	we
600	0.38
700	0.62
800	0.92
900	1.27
1000	1.60

2.2.1 Prediction of the gas composition

Introduction of the water-gas equilibrium concept provides the opportunity to calculate the gas composition theoretically from a gasifier which has reached equilibrium at a given temperature, as was shown by Tobler and Schlaepfer (34).

The procedure is to derive from mass balances of the four main ingoing elements (carbon, hydrogen, oxygen and nitrogen), an energy balance over the system and the relation given by the water-gas equilibrium. By further assuming that the amounts of methane in the producer gas per kg of dry fuel are constant (as is more or less the case of gasifiers under normal operating conditions) a set of relations becomes available permitting the calculation of gas compositions for a wide range of input parameters (fuel moisture content) and system characteristics (heat losses through convection, radiation and sensible heat in the gas). Theoretically calculated gas compositions-are given in figures 2.4 to 2.6. Generally a reasonably good agreement with experimental results is found.

Table 2.3 gives typical gas compositions as obtained from commercial wood and charcoal downdraught gasifiers operated on low to medium moisture content fuels (wood 20 percent, charcoal 7 percent).

Table 2.3 Composition of gas from-commercial wood and charcoal gasifiers.

Component	Wood Gas (vol. %)	Charcoal Gas (vol. %)
-----------	-------------------	-----------------------

Nitrogen	50 - 54	55 - 65
Carbon monoxide	17 - 22	28 - 32
Carbon dioxide	9 - 15	1 - 3
Hydrogen	12 - 20	4 - 10
Methane	2 - 3	0 - 2
Gas heating value kJ/m ³	5000 - 5900	4500 - 5600

2.2.2 Gasifier efficiency

An important factor determining the actual technical operation, as well as the economic feasibility of using a gasifier system, is the gasification efficiency.

A useful definition of the gasification efficiency if the gas is used for engine applications is:

$$\eta_{\text{m}} = \frac{H_{\text{g}} \times Q_{\text{g}}}{H_{\text{s}} \times M_{\text{s}}} \times 100 \quad (\%)$$

In which:

η_{m} = gasification efficiency (%) (mechanical)

H_{g} = heating value of the gas (kJ/m³), (see table 2.1 g or 2.3)

Q_{g} = volume flow of gas (m³/s)

H_{s} = lower heating value of gasifier fuel (kJ/kg) (see section 2.6)

M_{s} = gasifier solid fuel consumption (kg/s)

If the gas is used for direct burning, the gasification efficiency is sometimes defined as:

$$\eta_{\text{th}} = \frac{(H_{\text{g}} \times Q_{\text{g}}) + (Q_{\text{g}} \times \rho_{\text{g}} \times C_{\text{p}} \times \Delta T)}{H_{\text{s}} \times M_{\text{s}}} \times 100 \quad \%$$

In which:

η_{th} = gasification efficiency (%) (thermal)

ρ_{g} = density of the gas (kg/m³)

C_{p} = specific heat of the gas (kJ/kg°K)

ΔT = temperature difference between the gas at the burner inlet and the fuel entering the gasifier (°K).

Depending on type and design of the gasifier as well as on the characteristics of the fuel A_{m} may vary between 60 and 75 per cent. In the case of thermal applications, the value of η_{th} can be as high as 93 percent

Figure 2.4 Woodgas composition as a function of wood moisture content (15%-heat loss)

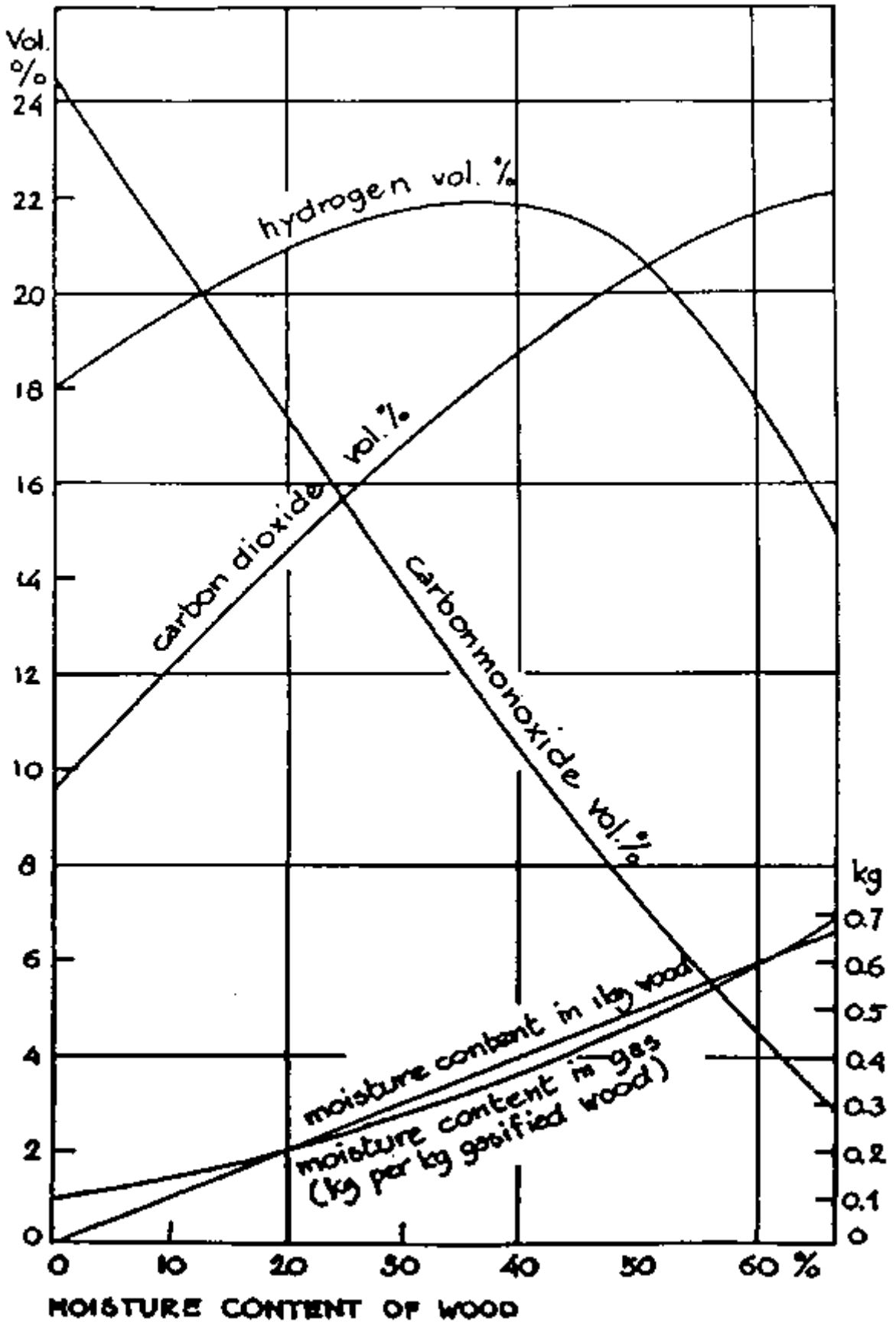

Figure 2.5 Calculated change of woodgas composition as a function of losses through convection and radiation

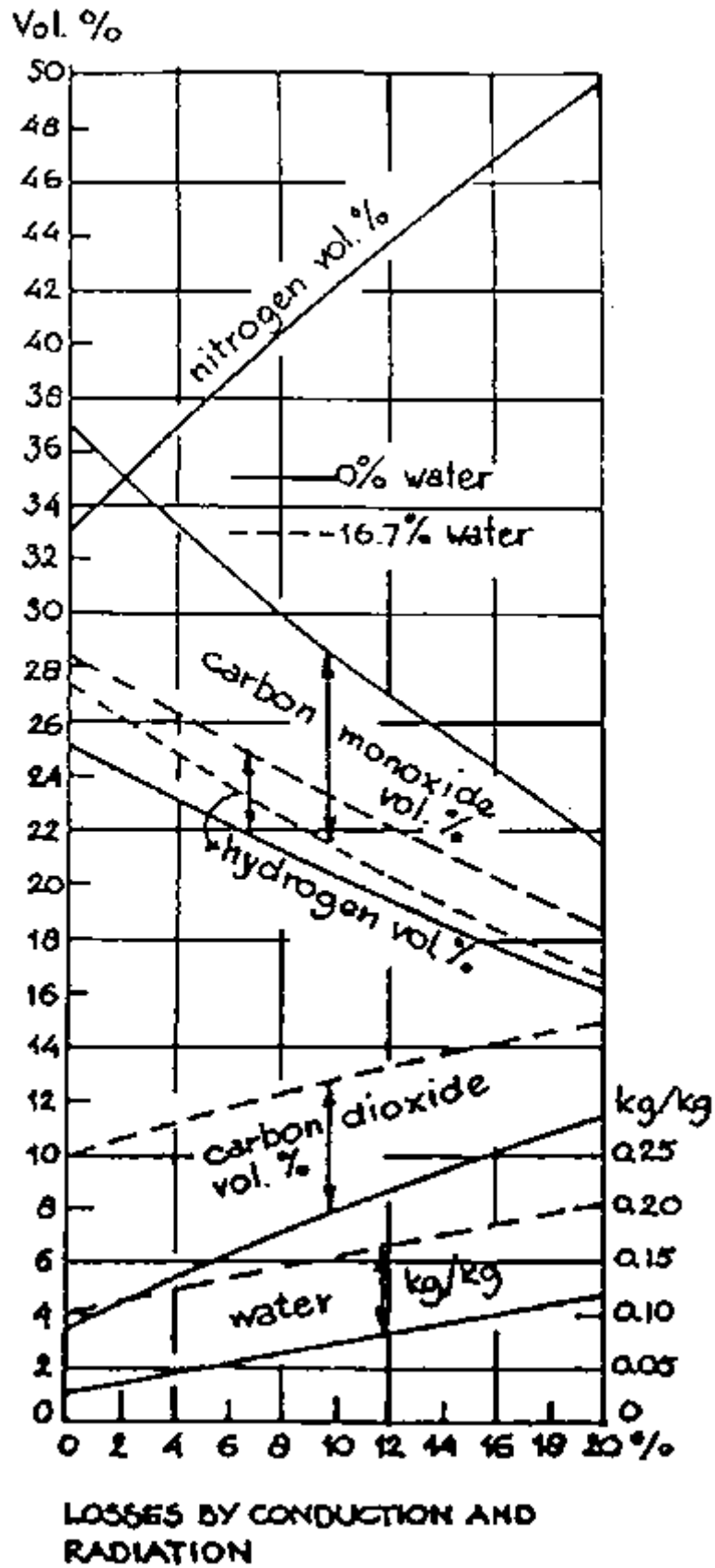
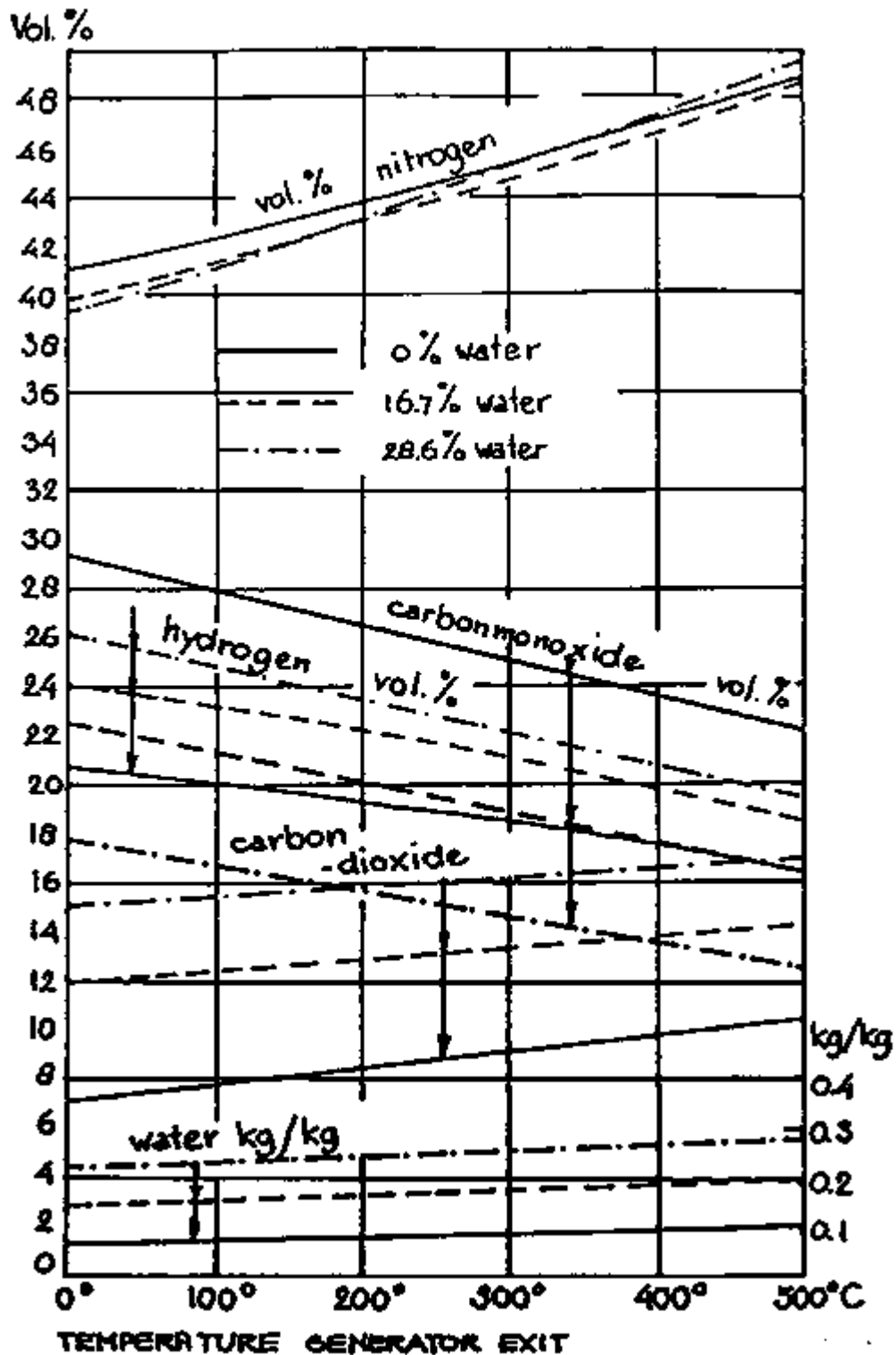

Figure 2.6 Calculated change of woodgas composition as a function of the gas outlet temperature (losses through sensible heat)



2.3 Types of gasifiers

2.3.1 Updraught or counter current gasifier

The oldest and simplest type of gasifier is the counter current or updraught gasifier shown schematically in Fig. 2.7.

Figure 2.7 Updraught or counter current gasifier

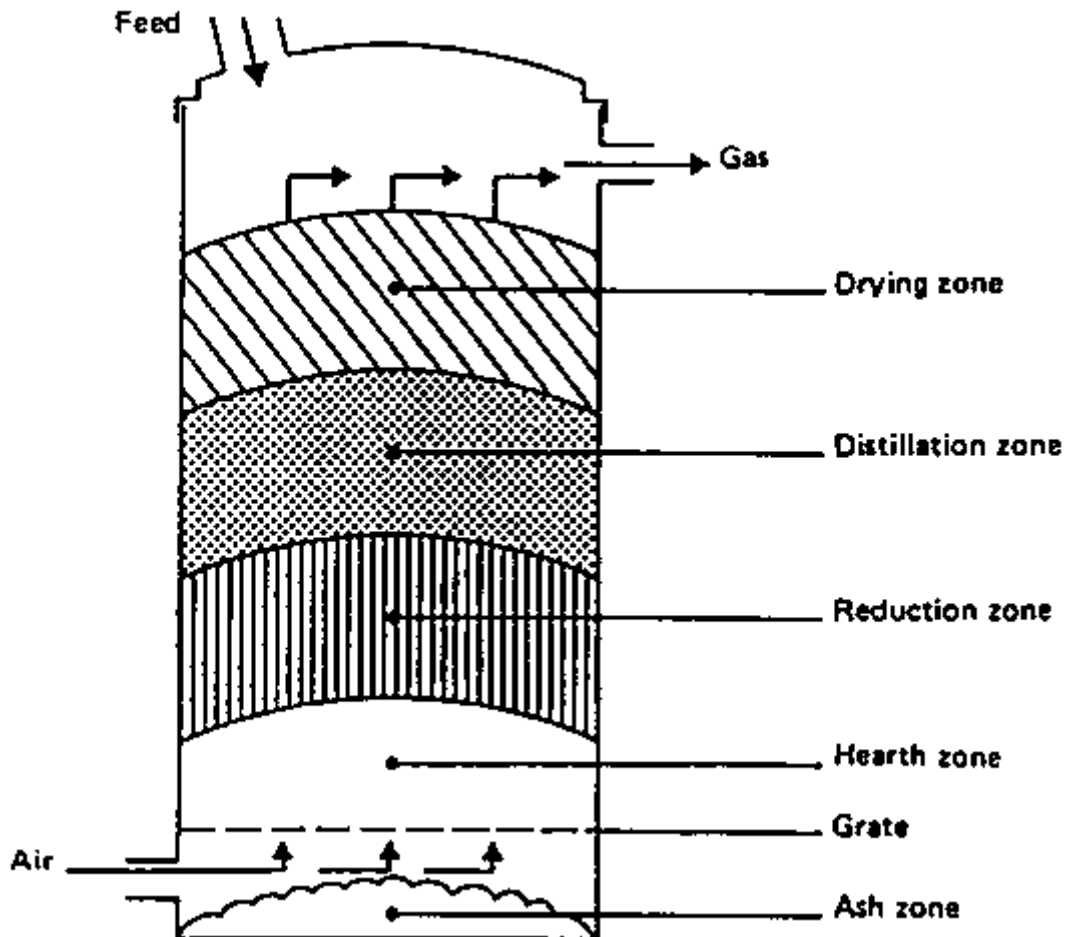

The air intake is at the bottom and the gas leaves at the top. Near the grate at the bottom the combustion reactions occur, which are followed by reduction reactions somewhat higher up in the gasifier. In the upper part of the gasifier, heating and pyrolysis of the feedstock occur as a result of heat transfer by forced convection and radiation from the lower zones. The tars and volatiles produced during this process will be carried in the gas stream. Ashes are removed from the bottom of the gasifier.

The major advantages of this type of gasifier are its simplicity, high charcoal burn-out and internal heat exchange leading to low gas exit temperatures and high equipment efficiency, as well as the possibility of operation with many types of feedstock (sawdust, cereal hulls, etc.) .

Major drawbacks result from the possibility of "channelling" in the equipment, which can lead to oxygen break-through and dangerous, explosive situations and the necessity to install automatic moving grates, as well as from the problems associated with disposal of the tar-

containing condensates that result from the gas cleaning operations. The latter is of minor importance if the gas is used for direct heat applications, in which case the tars are simply burnt.

2.3.2 Downdraught or co-current gasifiers

A solution to the problem of tar entrainment in the gas stream has been found by designing co-current or downdraught gasifiers, in which primary gasification air is introduced at or above the oxidation zone in the gasifier. The producer gas is removed at the bottom of the apparatus, so that fuel and gas move in the same direction, as schematically shown in Fig. 2.8.

Figure 2.8 Downdraught or co-current gasifier

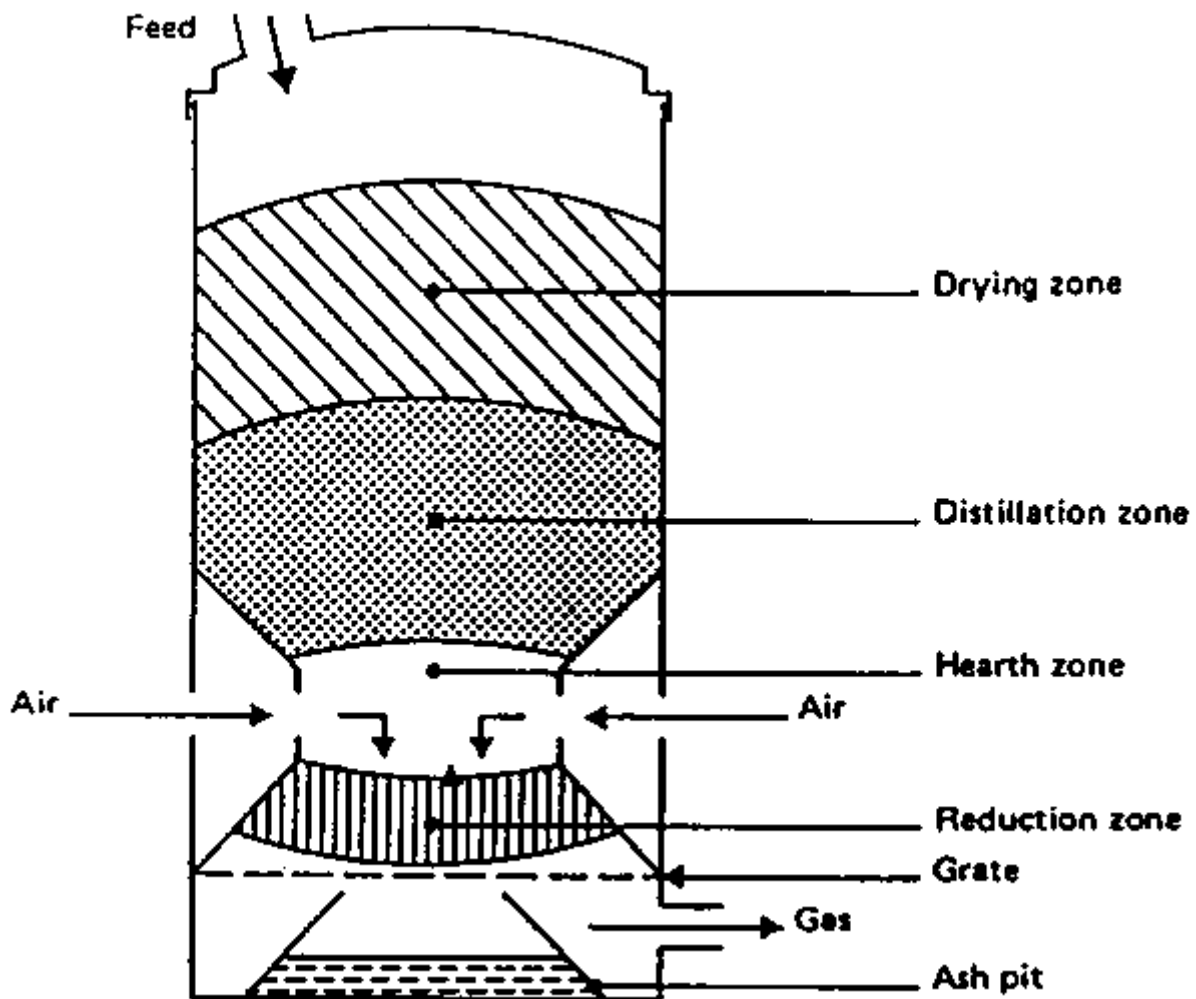

On their way down the acid and tarry distillation products from the fuel must pass through a glowing bed of charcoal and therefore are converted into permanent gases hydrogen, carbon dioxide, carbon monoxide and methane.

Depending on the temperature of the hot zone and the residence time of the tarry vapours, a more or less complete breakdown of the tars is achieved.

The main advantage of downdraught gasifiers lies in the possibility of producing a tar-free gas suitable for engine applications.

In practice, however, a tar-free gas is seldom if ever achieved over the whole operating range of the equipment: tar-free operating turn-down ratios of a factor 3 are considered standard; a factor 5-6 is considered excellent.

Because of the lower level of organic components in the condensate, downdraught gasifiers suffer less from environmental objections than updraught gasifiers.

A major drawback of downdraught equipment lies in its inability to operate on a number of unprocessed fuels. In particular, fluffy, low density materials give rise to flow problems and excessive pressure drop, and the solid fuel must be pelletized or briquetted before use. Downdraught gasifiers also suffer from the problems associated with high ash content fuels (slagging) to a larger extent than updraught gasifiers.

Minor drawbacks of the downdraught system, as compared to updraught, are somewhat lower efficiency resulting from the lack of internal heat exchange as well as the lower heating value of the gas. Besides this, the necessity to maintain uniform high temperatures over a given cross-sectional area makes impractical the use of downdraught gasifiers in a power range above about 350 kW (shaft power).

2.3.3. Cross-draught gasifier

Cross-draught gasifiers, schematically illustrated in Figure 2.9 are an adaptation for the use of charcoal. Charcoal gasification results in very high temperatures (1500 °C and higher) in the oxidation zone which can lead to material problems. In cross draught gasifiers insulation against these high temperatures is provided by the fuel (charcoal) itself.

Advantages of the system lie in the very small scale at which it can be operated. Installations below 10 kW (shaft power) can under certain conditions be economically feasible. The reason is the very simple gas-cleaning train (only a cyclone and a hot filter) which can be employed when using this type of gasifier in conjunction with small engines.

A disadvantage of cross-draught gasifiers is their minimal tar-converting capabilities and the consequent need for high quality (low volatile content) charcoal.

It is because of the uncertainty of charcoal quality that a number of charcoal gasifiers employ the downdraught principle, in order to maintain at least a minimal tar-cracking capability.

Figure 2.9 Cross-draught gasifier

2.3.4. Fluidized bed gasifier

The operation of both up and downdraught gasifiers is influenced by the morphological, physical and chemical properties of the fuel. Problems commonly encountered are: lack of bunkerflow, slagging and extreme pressure drop over the gasifier

A design approach aiming at the removal of the above difficulties is the fluidized bed gasifier illustrated schematically in Fig. 2.10.

Air is blown through a bed of solid particles at a sufficient velocity to keep these in a state of suspension. The bed is originally externally heated and the feedstock is introduced as soon as a sufficiently high temperature is reached. The fuel particles are introduced at the bottom of the reactor, very quickly mixed with the bed material and almost instantaneously heated up to the bed temperature. As a result of this treatment the fuel is pyrolysed very fast,

resulting in a component mix with a relatively large amount of gaseous materials. Further gasification and tar-conversion reactions occur in the gas phase. Most systems are equipped with an internal cyclone in order to minimize char blow-out as much as possible. Ash particles are also carried over the top of the reactor and have to be removed from the gas stream if the gas is used in engine applications.

Figure 2.10 Fluidized bed gasifier

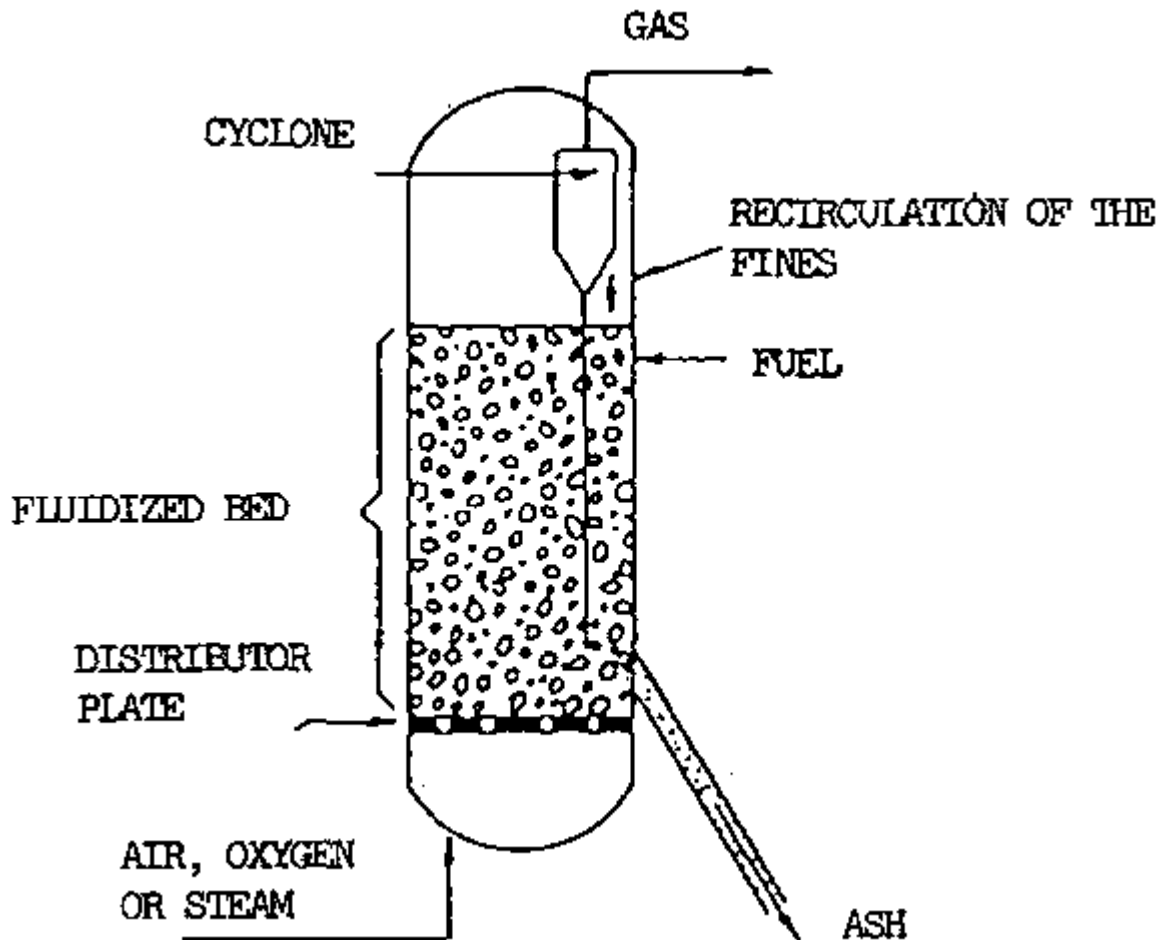

The major advantages of fluidized bed gasifiers, as reported by Van der Aarsen (44) and others, stem from their feedstock flexibility resulting from easy control of temperature, which can be kept below the melting or fusion point of the ash (rice husks), and their ability to deal with fluffy and fine grained materials (sawdust etc.) without the need of pre-processing. Problems with feeding, instability of the bed and fly-ash sintering in the gas channels can occur with some biomass fuels.

Other drawbacks of the fluidized bed gasifier lie in the rather high tar content of the product gas (up to 500 mg/m³ gas), the incomplete carbon burn-out, and poor response to load changes.

Particularly because of the control equipment needed to cater for the latter difficulty, very small fluidized bed gasifiers are not foreseen and the application range must be tentatively set at above 500 kW (shaft power).

Fluidized bed gasifiers are currently available on a semi-commercial basis from several manufacturers in Europe and U.S.A.

2.3.5 Other types of gasifiers

A number of other biomass gasifier systems (double fired, entrained bed, molten bath), which are partly spin-offs from coal gasification technology, are currently under development. In some cases these systems incorporate unnecessary refinements and complications, in others both the size and sophistication of the equipment make near term application in developing countries unlikely. For these reasons they are omitted from this account.

2.4 Gasification fuels

2.4.1 Need for selection of the right gasifier for each fuel

Biomass fuels available for gasification include charcoal, wood and wood waste (branches, twigs, roots, bark, woodshavings and sawdust) as well as a multitude of agricultural residues (maize cobs, coconut shells, coconut husks, cereal straws, rice husks, etc.) and peat.

Because those fuels differ greatly in their chemical, physical and morphological properties, they make different demands on the method of gasification and consequently require different reactor designs or even gasification technologies. It is for this reason that, during a century of gasification experience, a large number of different gasifiers has been developed and marketed, all types geared towards handling the specific properties of a typical fuel or range of fuels.

Thus it follows that the "universal" gasifier, able to handle all or most fuels or fuel types, does not exist, and in all probability will not exist in the foreseeable future.

The range of designs includes updraught, downdraught, crossdraught, fluidized bed as well as other biomass gasification systems of less importance (see section 2.3). All systems show relative advantages and disadvantages with respect to fuel type, application and simplicity of operation, and for this reason each will have its own technical and/or economic advantages in a particular set of circumstances.

Each type of gasifier will operate satisfactorily with respect to stability, gas quality, efficiency and pressure losses only within certain ranges of the fuel properties of which the most important are:

- energy content
- moisture content
- volatile matter
- ash content and ash chemical composition
- reactivity
- size and size distribution
- bulk density
- charring properties

Before choosing a gasifier for any individual fuel it is important to ensure that the fuel meets the requirements of the gasifier or that it can be treated to meet these requirements. Practical tests are needed if the fuel has not previously been successfully gasified.

In the next sections the most important fuel properties will be discussed and fuels of current interest will be reviewed.

2.4.2 Energy content of the fuel

The choice of a fuel for gasification will in part be decided by its heating value. The method of measurement of the fuel energy content will influence the estimate of efficiency of a given gasification system. Reporting of fuel heating values is often confusing since at least three different bases are used:

- fuel higher heating values as obtained in an adiabatic bomb calorimeter. These values include the heat of condensation of the water that is produced during combustion. Because it is very difficult to recover the heat of condensation in actual gasification operations these values present a too optimistic view of the fuel energy content;
- fuel higher heating values on a moisture-free basis, which disregard the actual moisture content of the fuel and so provide even more optimistic estimates of energy content;
- fuel higher heating values on a moisture and ash free basis, which disregard the incombustible components and consequently provide estimates of energy content too high for a given weight of fuel, especially in the case of some agricultural residues (rice husks).

The only realistic way therefore of presenting fuel heating values for gasification purposes is to give lower heating values (excluding the heat of condensation of the water produced) on an ash inclusive basis and with specific reference to the actual moisture content of the fuel. Average lower heating values of wood, charcoal and peat are given in Table 2.4.

Table 2.4 Average lower heating values

Fuel	Moisture content (%) ^{1/}	Lower heating value (kJ/kg)
wood	20 - 25	13 - 15000
charcoal	2 - 7	29 - 30000
peat	35 - 50	12 - 14000

^{1/} per cent of dry weight

2.4.3 Moisture content of the fuel

The heating value of the gas produced by any type of gasifier depends at least in part on the moisture content of the feedstock.

Moisture content can be determined on a dry basis as well as on a wet basis. In this chapter the moisture content (M.C.) on a dry basis will be used.

Moisture content is defined as:

$$M.C._{dry} = \frac{\text{wet weight} - \text{dry weight}}{\text{dry weight}} \times 100 \%$$

Alternatively the moisture content on a wet basis is defined as:

$$M.C._{wet} = \frac{\text{wet weight} - \text{dry weight}}{\text{wet weight}} \times 100 \%$$

Conversions from one to another can be obtained by:

$$M.C._{dry} = \frac{100 \times M.C._{wet}}{100 + M.C._{wet}}$$

and:

$$M.C._{wet} = \frac{100 \times M.C._{dry}}{100 + M.C._{dry}}$$

High moisture contents reduce the thermal efficiency since heat is used to drive off the water and consequently this energy is not available for the reduction reactions and for converting thermal energy into chemical bound energy in the gas. Therefore high moisture contents result in low gas heating values.

When the gas is used for direct combustion purposes, low heating values can be tolerated and the use of feedstocks with moisture contents (dry basis) of up to 40 - 50 percent is feasible, especially when using updraught gasifiers.

In downdraught gasifiers high moisture contents give rise not only to low gas heating values, but also to low temperatures in the oxidation zone, and this can lead to insufficient tar converting capability if the gas is used for engine applications.

Both because of the gas heating value (engines need gas of at least 4200 kJ/m³ in order to maintain a reasonable efficiency) and of the tar entrainment problem, downdraught gasifiers need reasonably dry fuels (less than 25 percent moisture dry basis).

2.4.4 Volatile matter content of the fuel

The amount of volatiles in the feedstock determines the necessity of special measures (either in design of the gasifier or in the layout of the gas cleanup train) in order to remove tars from the product gas in engine applications.

In practice the only biomass fuel that does not need this special attention is good-quality charcoal.

The volatile matter content in charcoal however is often underestimated and in practice may be anything from 3 to 30 percent or more. As a general rule if the fuel contains more than 10 percent volatile matter it should be used in downdraught gas producers, but even in this case the method of charcoal production should be taken into account. Charcoal produced in large scale retorts is fairly consistent in volatile matter content, but large differences can be observed in charcoal produced from small scale open pits or portable metal kilos that are common in most developing countries.

2.4.5 Ash content and ash chemical composition

Ashes can cause a variety of problems particularly in up or downdraught gasifiers. Slagging or clinker formation in the reactor, caused by melting and agglomeration of ashes, at the best will greatly add to the amount of labour required to operate the gasifier. If no special measures are taken, slagging can lead to excessive tar formation and/or complete blocking of the reactor. A worst case is the possibility of air-channelling which can lead to a risk of explosion, especially in updraught gasifiers.

Whether or not slagging occurs depends on the ash content of the fuel, the melting characteristics of the ash, and the temperature pattern in the gasifier. Local high temperatures in voids in the fuel bed in the oxidation zone, caused by bridging in the bed, may cause slagging even using fuels with a high ash melting temperature.

In general, no slagging is observed with fuels having ash contents below 5-6 percent. Severe slagging can be expected for fuels having ash contents of 12 percent and above. For fuels with ash contents between 6 and 12 percent, the slagging behaviour depends to a large extent on the ash melting temperature, which is influenced by the presence of trace elements giving rise to the formation of low melting point eutectic mixtures.

For gasification purposes the melting behaviour of the fuel ash should be determined in both oxidating and reducing atmospheres.

As far as ash content is concerned, raw wood and wood charcoals seldom present problems, the ash content being normally from 0.75 to 2.5 percent. However, in a number of tropical woods (22) charcoal ash contents may be much higher and those charcoal types are unsuitable for gasification purposes. Table 2.5 lists agricultural residues which have been tested with respect to their slagging properties in a small downdraught laboratory gas producer (19).

Up and downdraught gasifiers are able to operate with slagging fuels if specially modified (continuously moving grates and/or external pyrolysis gas combustion). Cross draught gasifiers, which work at very high temperatures of 1500° C and above, need special safeguards with respect to the ash content of the fuel. Fluidized bed reactors, because of their inherent capacity to control the operating temperature, suffer less from ash melting and fusion problems.

Table 2.5 Slagging of agricultural residues in a small laboratory down draught gasifier (Jenkins, (19))

<u>Slagging fuels</u>	<u>Ash content percent</u>	<u>Degree of slagging</u>
Barley straw mix	10.3	severe
Bean straw	10.2	"
Corn stalks	6.4	moderate
Cotton gin trash	17.6	severe
Cubed cotton stalks	17.2	"
RDF pellets ^{1/}	10.4	"
Pelleted rice hulls	14.9	"
Safflower straw	6.0	minor
Pelleted walnut shell mix	5.8	moderate
Wheat straw and corn stalks	7.4	severe

^{1/} RDF = refuse derived fuel

<u>Non slagging fuels</u>	

Cubed alfalfa seed straw	6.0
Almond shell	4.8
Corn cobs	1.5
Olive pits	3.2
Peach pits	0.9
Prune pits	0.5
Walnut shell (cracked)	1.1
Douglas fir wood blocks	0.2
Municipal tree prunings	3.0
Hogged wood manufacturing residues	0.3
Whole log wood chips	0.1

2.4.6 Reactivity of the fuel

The reactivity is an important factor determining the rate of reduction of carbon dioxide to carbon monoxide in a gasifier. Reactivity influences the reactor design insofar as it dictates the height needed in the reduction zone.

In addition certain operational characteristics of the gasification system (load following response, restarting after temporary shutdown) are affected by the reactivity of the char produced in the gasifier. Reactivity depends in the first instance on the type of fuel. For example, it has been observed that fuels such as wood, charcoal and peat are far more reactive than coal.

Undoubtedly, there is a relation between reactivity and the number of active places on the char surface, these being influenced by the morphological characteristics as well as the geological age of the fuel. The grain size and the porosity of the char produced in the reduction zone influence the surface available available for reduction and, therefore, the rate of the reduction reactions.

It is well known that the reactivity of char can be improved through various processes such as steam treatment (activated carbon) or treatment with lime and sodium carbonate.

Another interesting point is the assumed positive effect on the rate of gasification of a number of elements which act as catalysts. Small quantities of potassium, sodium and zinc can have a large effect on the reactivity of the fuel.

2.4.7 Particle size and size distribution

Up and draught gasifiers are limited in the range of fuel size acceptable in the feed stock. Fine grained and/or fluffy feedstock may cause flow problems in the bunker section of the gasifier as well as an inadmissible pressure drop over the reduction zone and a high proportion of dust in the gas. Large pressure drops will lead to reduction of the gas load of draught equipment, resulting in low temperatures and tar production.

Excessively large sizes of particles or pieces give rise to reduced reactivity of the fuel, resulting in startup problems and poor gas quality, and to transport problems through the equipment. A large range in size distribution of the feedstock will generally aggravate the above phenomena. Too large particle sizes can cause gas channelling problems, especially in updraught gasifiers.

Acceptable fuel sizes for gasification systems depend to a certain extent on the design of the units. In general, wood gasifiers operate on wood blocks and woodchips ranging from 8 x 4 x 4 cm. to 1 x 0.5 x 0.5 cm. Charcoal gasifiers are generally fuelled by charcoal lumps ranging between 1 x 1 x 1 cm. and 3 x 3 x 3 cm. Fluidized bed gasifiers are normally able to handle fuels with particle diameters varying between 0.1 and 20 mm.

2.4.8 Bulk density of the fuel

Bulk density is defined as the weight per unit volume of loosely tipped fuel. Fuels with high bulk density are advantageous because they represent a high energy-for-volume value. Consequently these fuels need less bunker space for a given refuelling time. Low bulk density fuels sometimes give rise to insufficient flow under gravity, resulting in low gas heating values and ultimately in burning of the char in the reduction zone. Average bulk densities of wood, charcoal and peat are given in Table 2.6. Inadequate bulk densities can be improved by briquetting or pelletizing.

Table 2.6 Average bulk densities

Fuel	Bulk density (kg/m ³) ^{1/}
Wood	300 - 550
Charcoal	200 - 300
Peat	300 - 400

^{1/} The bulk density varies significantly with moisture content and particle size of the fuel.

2.4.9 Charring properties of the fuel

The occurrence of physical and morphological difficulties with charcoal produced in the oxidation zone has been reported. Some feedstocks (especially softwoods) produce char that shows a tendency to disintegrate. In extreme cases this may lead to inadmissible pressure drop.

A number of tropical hardwoods (notably teak) are reported (38) to call for long residence times in the pyrolysis zone, leading to bunker flow problems, low gas quality and tar entrainment.

2.4.10 Assessment of the suitability of various types of biomass as gasifier fuel

Charcoal

Because good quality charcoal contains almost no tars it is a feasible fuel for all types of gasifiers. Good gasifier charcoal is low in mineral matter and does not crumble or disintegrate easily.

The major disadvantages are the relatively high cost of charcoal, which reduces its competitiveness as compared to liquid fuel, and the energy losses which occur during charcoal manufacture (up to 70% of the energy originally present in the wood may be lost). This latter factor may be of special importance for those developing countries which already suffer from an insufficient biomass energy base to cater for their domestic energy requirements.

Experience has shown that most types of wood as well as some agricultural residues (e.g. coconut shell) can provide first class gasification charcoal.

Wood

Most wood species have ash contents below two percent and are therefore suitable fuels for fixed bed gasifiers

Because of the high volatile content of wood, updraught systems produce a tar-containing gas suitable mainly for direct burning. Cleaning of the gas to make it suitable for engines is rather difficult and capital and labour intensive. Downdraught systems can be designed to deliver a virtually tar-free product gas in a certain capacity range when fuelled by wood blocks or wood chips of low moisture content. After passing through a relatively simple clean-up train the gas can be used in internal combustion engines.

Sawdust

Most currently available downdraught gasifiers are not suitable for unpelletized sawdust. Problems encountered are: excessive tar production, inadmissible pressure drop and lack of bunkerflow.

Fluidized bed gasifiers can accommodate small sawdust particles and produce burner quality gas. For use in engines, a fairly elaborate clean-up system is necessary.

Peat

The biggest problems in gasification of peat is encountered with its high moisture content and often also with its fairly high ash content. Updraught gasifiers fuelled with sod peat of approximately 30 - 40% moisture content have been installed in Finland for district heating purposes and small downdraught gasifiers fuelled with fairly dry peat-pellets have been successfully tested in gas-engine applications (25). During the Second World War a lot of transport vehicles were converted to wood or peat gas operation, both in Finland and Sweden.

Agricultural residues

In principle, developing countries have a wide range of agricultural residues available for gasification.

In practice, however, experience with most types of waste is extremely limited. Coconut shells (10) and maize cobs (39) are the best documented and seem unlikely to create serious problems in fixed bed gasifiers. Coconut husks (35) are reported to present bridging problems in the bunker section, but the material can be gasified when mixed with a certain quantity of wood. Most cereal straws have ash contents above ten per cent and present slagging problems in downdraught gasifiers (18). Rice husks can have ash contents of 20 percent and above and this is probably the most difficult fuel available. Research into downdraught gasifier designs for this material is continuing (21) while published information indicates that Italian up-draught gasifiers have been powering small rice mills for decades (5). The system seems to have been revived in China, where a number of updraught gasifiers are reported to be in operation (28).

It is possible to gasify most types of agricultural waste in pre-war design updraught gasifiers. However, the capital, maintenance and labour costs, and the environmental consequences (disposal of tarry condensates) involved in cleaning the gas, prevent engine applications

under most circumstances. Downtraught equipment is cheaper to install and operate and creates fewer environmental difficulties, but at present technology is inadequate to handle agricultural residues (with the possible exception of maize cobs and coconut shells) without installing expensive (and partly unproven) additional devices.

Even for coconut shells and maize cobs, the information available is based on a limited number of operating hours and must be further verified under prolonged (say 10000 hours) tests in practical conditions. Fluidized bed gasifiers show great promise in gasifying a number of "difficult" agricultural wastes. Currently, only semi-commercial installations are available and operating experience is extremely limited. It is for this reason that no immediate application in developing countries is foreseen.

2.5 Design of downtraught gasifiers

The downtraught gasifier makes it possible to use wood as fuel and produce a gas with sufficiently low tar content to operate an internal combustion engine. There are other means of handling the tar problem but these may create their own problems. For example, use of charcoal as fuel involves a loss of energy and increases the risk of depletion of wood resources. Use of cleaning systems after the gasifier involves difficult waste disposal problems.

Down-draught gasifiers being comparatively easy to build and operate, are likely to be the most appropriate for developing countries as a source of decentralized power supply to rural communities and industries.

The conversion of solid fuel to gas in a down-draught gasifier and the design basis for such gasifiers will therefore be examined in more detail.

2.5.1 Processes occurring in the down-draught gasifier

In the down-draught gasifier, schematically illustrated in Fig. 2.8, the fuel is introduced at the top, the air is normally introduced at some intermediate level and the gas is taken out at the bottom.

It is possible to distinguish four separate zones in the gasifier, each of which is characterized by one important step in the process of converting the fuel to a combustible gas. The processes in these four zones are examined below and the design basis will be discussed in the following section.

a) Bunker Section (drying zone)

Solid fuel is introduced into the gasifier at the top. It is not necessary to use complex fuel-feeding equipment, because a small amount of air leakage can be tolerated at this spot. As a result of heat transfer from the lower parts of the gasifier, drying of the wood or biomass fuel occurs in the bunker section.

The water vapour will flow downwards and add to the water vapour formed in the oxidation zone. Part of it may be reduced to hydrogen (see equation (b), paragraph 2.2) and the rest will end up as moisture in the gas.

b) Pyrolysis Zone

At temperatures above 250°C, the biomass fuel starts pyrolysing. The details of these pyrolysis reactions are not well known, but one can surmise that large molecules (such as cellulose, hemi-cellulose and lignin) break down into medium size molecules and carbon (char) during the heating of the feedstock. The pyrolysis products flow downwards into the hotter zones of the gasifier. Some will be burned in the oxidation zone, and the rest will break down to even smaller molecules of hydrogen, methane, carbon monoxide, ethane, ethylene, etc. if they remain in the hot zone long enough.

If the residence time in the hot zone is too short or the temperature too low, then medium sized molecules can escape and will condense as tars and oils, in the low temperature parts of the system.

c) Oxidation Zone

A burning (oxidation) zone is formed at the level where oxygen (air) is introduced. Reactions with oxygen are highly exothermic and result in a sharp rise of the temperature up to 1200 - 1500 °C.

As mentioned above, an important function of the oxidation zone, apart from heat generation, is to convert and oxidize virtually all condensable products from the pyrolysis zone. In order to avoid cold spots in the oxidation zone, air inlet velocities and the reactor geometry must be well chosen.

Generally two methods are employed to obtain an even temperature distribution:

- reducing the cross-sectional area at a certain height of the reactor ("throat" concept),
- spreading the air inlet nozzles over the circumference of the reduced cross-sectional area, or alternatively using a central air inlet with a suitable spraying device.

Guidelines for throat designs are given in the next section.

d) Reduction zone

The reaction products of the oxidation zone (hot gases and glowing charcoal) move downward into the reduction zone.

In this zone the sensible heat of the gases and charcoal is converted as much as possible into chemical energy of the producer gas (see equations (a) (b), section 2.2).

The end product of the chemical reactions that take place in the reduction zone is a combustible gas which can be used as fuel gas in burners and after dust removal and cooling is suitable for internal combustion engines.

The ashes which result from gasification of the biomass should occasionally be removed from the gasifier. Usually a moveable grate in the bottom of the equipment is considered necessary. This makes it possible to stir the charcoal bed in the reduction zone, and thus helps to prevent blockages which can lead to obstruction of the gas flow.

2.5.2 Design guidelines for downdraught gasifiers

A review of the design characteristics of the Imbert gasifier (Fig. 2.11) has been compiled on the basis of Swedish experience (43).

Figure 2.11 Sketch of an Imbert type gasifier

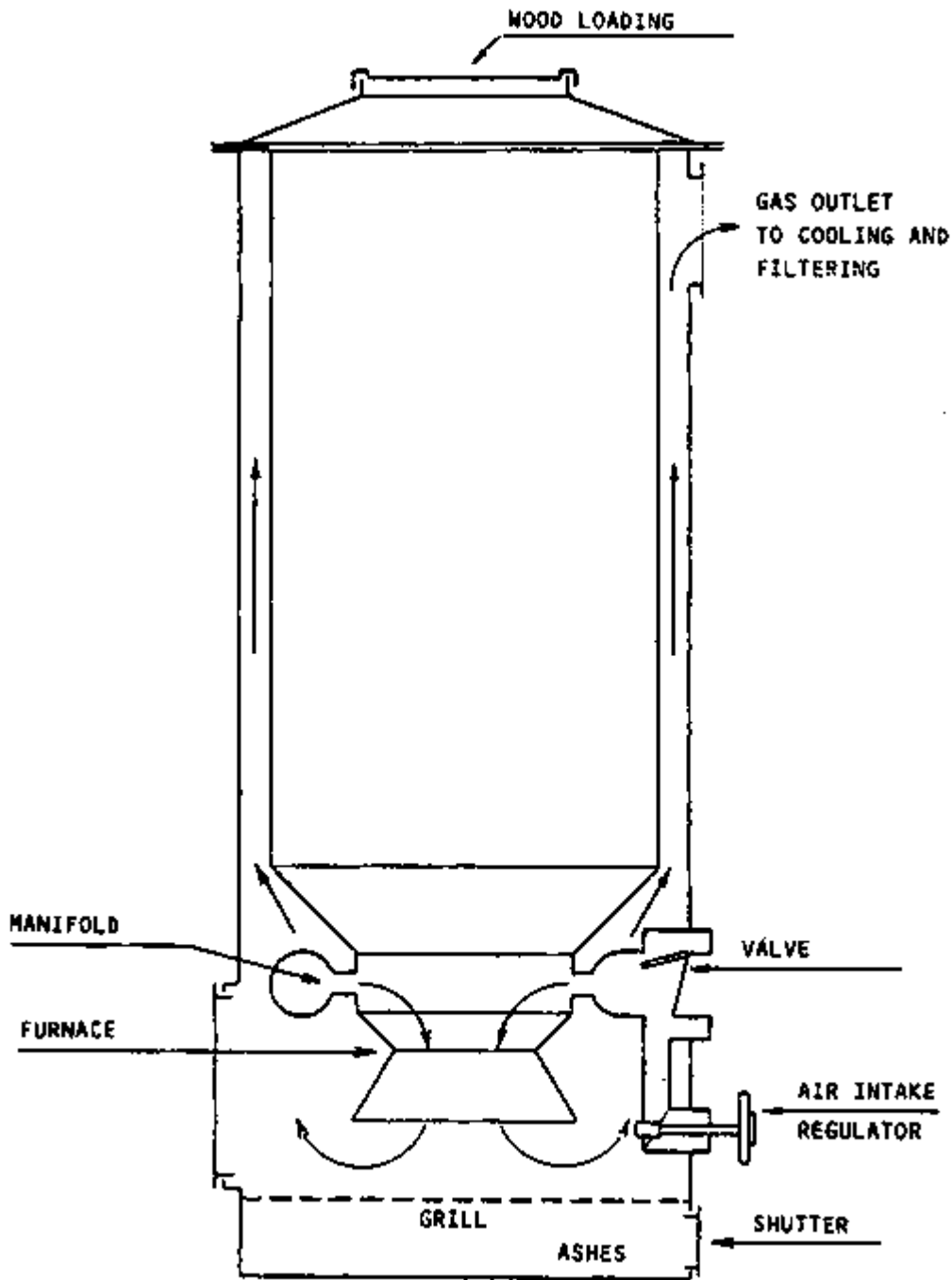

Dimensioning of the Imbert gasifier is closely related to the "hearth load" concept. The hearth load B is defined as the amount of producer gas reduced to normal (p, T) conditions, divided by the surface area of the "throat" at the smallest circumference and is usually expressed in $m^3/cm^2/h$. Alternatively the hearth load can be expressed as the amount of dry fuel consumed, divided by the surface area of the narrowest constriction (B_s), in which case hearth load is expressed in $Kg/cm^2/h$. Because one kilogramme of dry fuel under normal circumstances produces about $2.5 m^3$ of producer gas, the relation between B_g and B_s is given by:

$$B_g = 2.5 B_s$$

According to the information provided in (8) B_g may reach a maximum value of about 0.9 ($B_s = 0.36$) in continuous operation in good "Imbert" type gasifiers. Higher values of B_g give rise to extreme pressure drop over the reduction zone of the equipment.

Minimum values of B_g depend essentially on the heat insulation of the hot zone. Below a certain hearth load the temperature in the hot zone is lowered so much that tar production becomes inevitable.

Normal "Imbert" type generators show minimum values of B_g in the range of 0.30 - 0.35, resulting in power turn-down ratios of a factor 2.5 - 3. Modern gas producers are better insulated, and can operate tar-free at B_g values of 0.15 - 0.18.

Designing an "Imbert" type gasifier now boils down to estimating the maximum amount of gas needed. This is easily done by taking into account the cylinder volume and number of revolutions as well as the volumetric efficiency of an internal combustion engine coupled to the system (see section 2.1 and Appendix 1). From this gas amount as well as from the B maximum value (0.9) the area of the smallest constriction and the diameter of the throat can be calculated.

The Swedish Academy of Engineering Sciences (43), also presents empirical data with regard to the height of the nozzles above the narrowest constriction, the diameter of nozzle opening ring as well as of suitable nozzles for different capacities.

These data are reproduced in Figures 2.12 to 2.14 and in Table 2.7.

Figure 2.12 Height of the nozzle plane above the hearth constriction for various generator sizes

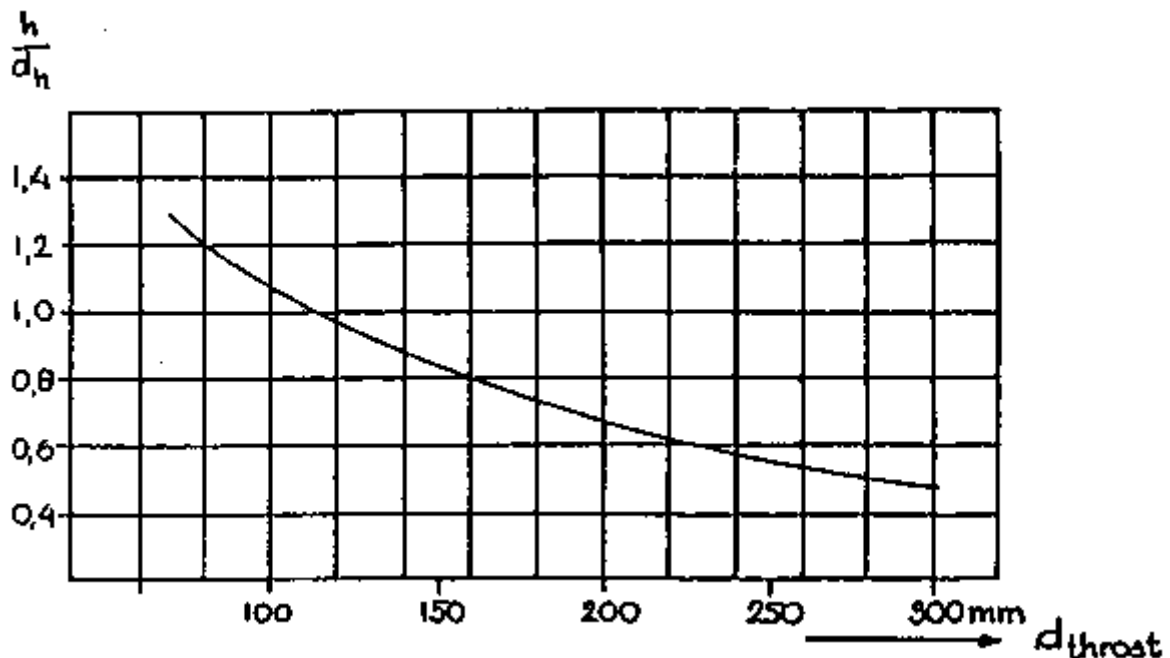

Table 2.7 Suitable nozzles for wood gas generators operating with four-cycle engines (43)

d_t	d_n	n
mm	mm	

70	10.5	3
80	9	5
90	10	5
100	11	5
120	12.7	5
130	13.5	5
150	15	5
170	14.3	7
190	16	7
220	18	7
270	22	7
300	24	7

d_t = diameter of throat at smallest cross-sectional area

d_n = nozzle diameter

n = number of nozzles to be installed

Figure 2.13 Graph of suitable nozzles for operating four-cycle engines with several cylinders

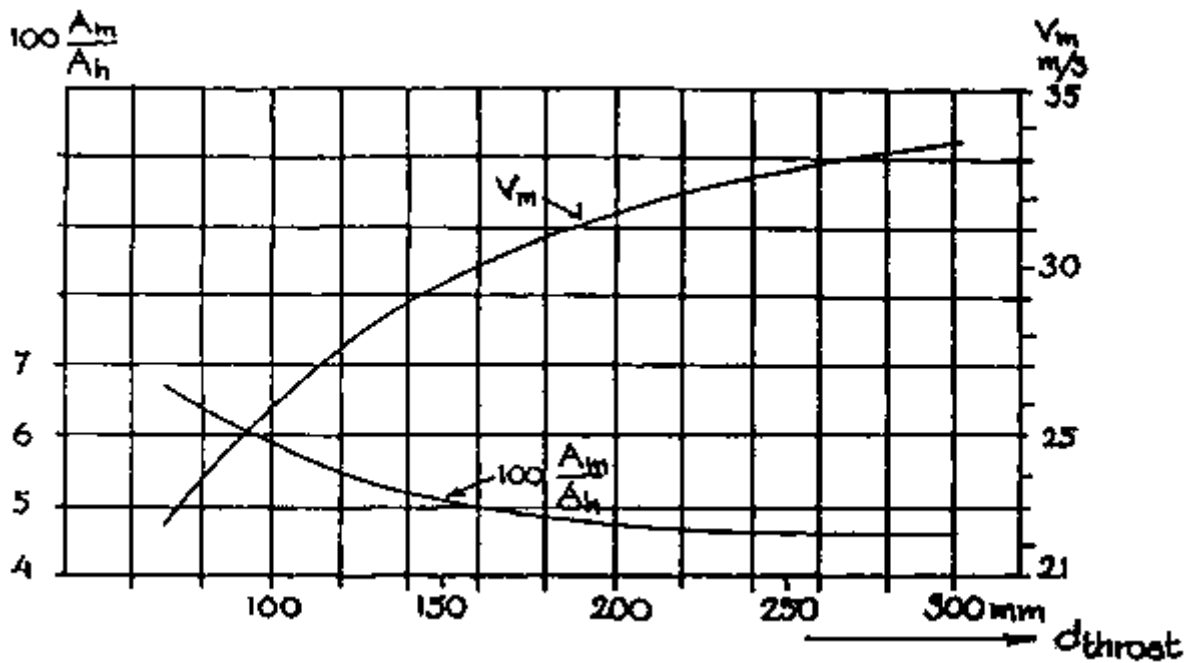
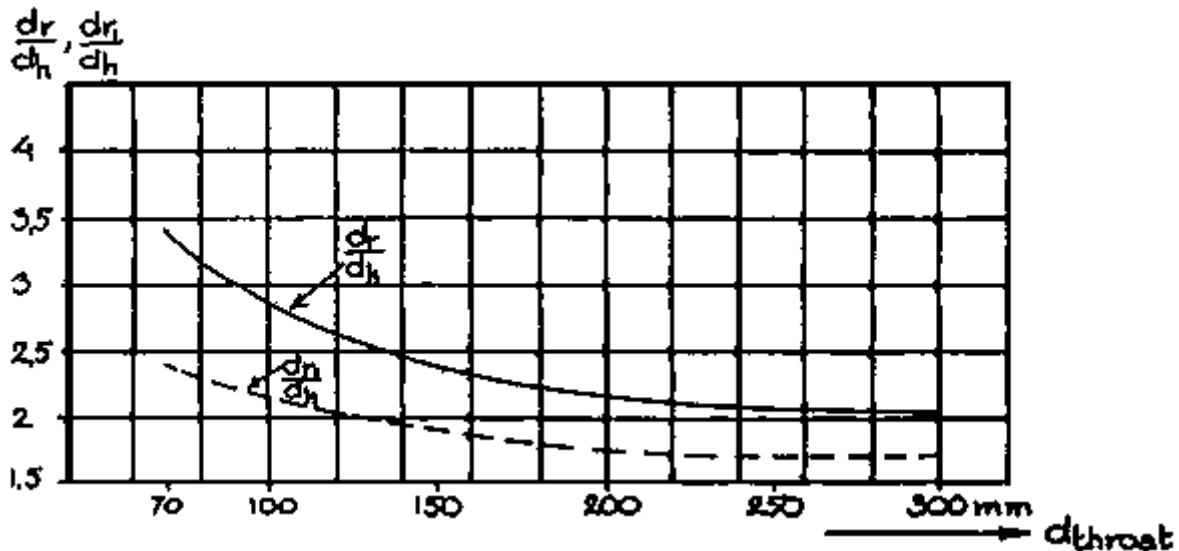

Figure 2.14 Diameter of nozzle ring and nozzle opening in relation to hearth constriction, as a function of hearth diameter, for various generator makes



Venselaar (46) compares the design characteristics of a number of gasifiers that were commercially available during the Second World War. A distinction is made between "no throat" "single throat" and "double throat" (Imbert type) designs (see Figure 2.15). He comes to the conclusion that the three types differ mainly in maximum allowable hearth load, giving values of B_{max} of 0.03, 0.11 and 0.4, respectively for "no throat", "single throat" and "double throat" gasifiers.

Further conclusions from this comparison are that:

- nozzle air inlet velocities should be around 30 - 35 m/s;
- throat inclination should be around $45^\circ - 60^\circ$;
- hearth diameter at air inlet height should be 10 cm larger than "throat" diameter in case of a "single" throat design, and about 20 cm larger than the diameter of the narrowest constriction in case of "double" throat design;
- height of the reduction zone should be more than 20 cm (the average height of reduction zone for the gasifiers reviewed was 32 cm);
- height of the air inlet nozzle plane should be 10 cm above the narrowest constriction.

As far as "double throat" or "Imbert type" gasifiers are concerned, there is good agreement between design rules presented by the authors of (43) and (46).

It must be emphasized that the above empirical design rules are based on experiences with gas producers fuelled by wood blocks varying in size between 3 to 5 x 6 to 8 cm.

A more theoretical approach is given by Groeneveld (17) who points out the importance of the fuel size. He proposes that the determining factor of the maximum load of any given gasifier is the residence time of the fuel in the pyrolysis zone. If this residence time is too short, heat penetration into a given fuel particle is insufficient to cause complete

devolatilization. Consequently further production of volatiles will occur in the reduction zone, leading to tar evolution and tar entrainment in the product gas.

Groeneveld (17) takes the time necessary for complete devolatilization to be equal to or larger than the Fourier time for heating up. By making some assumptions about the extension and geometry of the pyrolysis zone, a maximum gasifier load independent of the fuel particle size can be calculated.

Figure 2.15 Classification of down-draught gasifiers according to Venselaar (46)

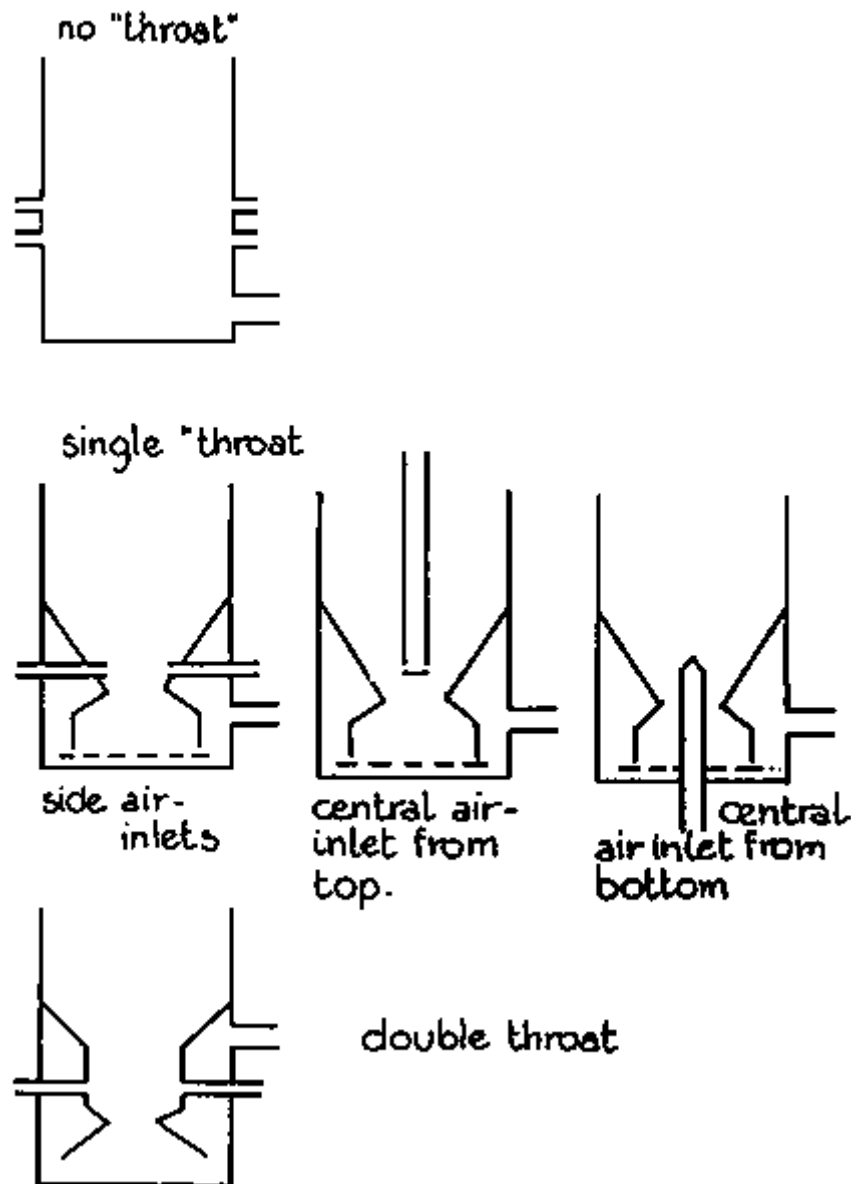

In comparing Groeneveld's calculations with actually measured maximum gasifier loads, calculated loads seem to be too high by a factor of 1.5 - 2. The reasons for this discrepancy are not completely clear. Venselaar proposes a time-lag between complete heating up and complete devolatilization. Alternatively, the influence of the particle size distribution on the outcome of the maximum load calculations may have to be considered (see Appendices 1 and 2).

2.6 Gas cleaning and cooling

Trouble free operation of an internal combustion engine using producer gas as fuel requires a fairly clean gas (see section 2.1.3).

As has been mentioned in sections 2.3 and 2.5 well designed downdraught gasifiers are able to meet the criteria for cleanliness at least over a fairly wide capacity range (i.e. from 20% - 100% of full load). Up draught gasifiers in engine applications have to be fitted with bulky and expensive tar separating equipment. It is however possible to get the gas from up draught gasifiers up to specification as is reported by Leuchs (26). Methods are under development to reform the gas in a high temperature zone (secondary gasification), in order either to burn or crack the tars.

When suitable fuels are used, the gasifier and cleaner are well designed and the gasifier is operated above minimum capacity, tar contamination of the gas does not present a major problem.

Gas cooling mainly serves the purpose of increasing the density of the gas in order to maximize the amount of combustible gas entering the cylinder of the engine at each stroke. A ten percent temperature reduction of the gas increases the maximum output of the engine by almost two percent. Cooling also contributes to gas cleaning and makes it possible to avoid condensation of moisture in the gas after it is mixed with air before the engine intake.

2.6.1 Cleaning dust from the gas

The major problem in producing an engine quality gas is that of dust removal.

The amount of dust that is present in the producer gas at the outlet of the gasifier depends on the design of the equipment, the load of the gasifier and the type of fuel used.

In most gasifiers the direction of the gas stream is already reversed over 180° inside the apparatus, and this simple measure removes the coarsest dust.

The amount of dust present in the gas per m³ generally increases with the gasifier load, for the simple reason that higher loads give rise to higher gas velocities and more dust dragging.

Smaller fuel particles generally cause higher dust concentrations in the gas than do the larger fuel blocks. The type of fuel also has an influence: hardwoods generally generate less dust than softwoods. Maize cob gasification leads to severe dust contamination as reported by Zijp et al. (48).

For normal type "Imbert" downdraught gasifiers, the dust leaks when using wood blocks of about 4 x 4 x 4 cm are reported to vary between 0.5 - 5 g/m³ gas (34).

Investigations of the size and size distribution of generator gas dust were undertaken by Nordström (33) and the results are reproduced in Table 2.8. It is possible to separate about 60% - 70% of this dust from the gas stream by means of a well designed cyclone.

The rest (dust particles of smaller diameter) has to be removed by other means.

Table 2.8 Size distribution of producer gas dust (33)

Particle size of dust m.10 ⁻⁶	Percentage in the gas %
over 1000	1.7
1000 - 250	24.7
250 - 102	23.7
102 - 75	7.1
75 - 60	8.3
under 60	30.3
losses	4.2

During the Second World War a multitude of dry filters containing wood wool, sisal fibre, glass wool, wood chips soaked in oil, and other types of fibrous or granular material were used for removal of the fine dust (average particle size below 60 micron), but success was very limited.

Wet purifiers such as water and oil scrubbers and bubblers are also effective but only within certain limits.

The best cleaning effect is obtained by employing cloth filters. However, normal cloth filters are very sensitive to the gas temperature. In the case of wood or agricultural waste gasification, the dew-point of the gas will be around 70 C. Below this temperature water will condense in the filters, causing obstruction of the gas flow and an unacceptable pressure drop over the filter section of the gasification system.

At higher temperatures normal cloth filters are likely to char and decompose in the hot gas stream. Another of their disadvantages is that they are subject to a rapid build-up of dust and so need frequent cleaning if not used in conjunction with a pre-filtering step.

The disadvantages of cloth filters can be partly offset by using woven glasswool filter bags as proposed by Nordstrom (33). This material can be used at temperatures up to 300°C. By heating (insulated) filter housing by means of the hot gas stream coming from the gasifier, temperatures above 100°C can be maintained in the filter, thus avoiding condensation and enhanced pressure drop. If a pre-filtering step consisting of a cyclone and/or an impingement filter is employed. It is possible to keep the service and maintenance intervals within reasonable limits, i.e. cleaning each 100-150 h. This combination is probably the most suitable for small and medium-sized systems (up to 150 kW electric power), and experience has shown that engine wear is no greater than with liquid fuels (33).

Electrostatic filters are also known to have very good particle separating properties, and most probably they could also be used to produce a gas of acceptable quality. However, such filters are expensive, and it is for this reason that their use is foreseen only in larger installations, i.e. equipment producing 500 kW electric power and more.

2.6.2 Gas cooling

An excellent presentation of generator gas cooling theory is to be found in (43). Major factors to be taken into consideration are the sensible heat in the gas, the water vapour content of the gas and its heat of condensation and the effects of fouling of the cooler.

Generator gas coolers come in three broad categories: natural convection coolers, forced convection coolers and water coolers.

Natural convection coolers consist of a simple length of pipe. They are simple to use and clean and require no additional energy input. They can be rather bulky, though this problem can be partly offset by using fined pipe in order to increase the conductive surface. Forced convection coolers are equipped with a fan which forces the cooling air to flow around the gas pipes. This type of cooler can be much smaller than the natural convection coolers. Its disadvantages are the extra energy input to the fan and the necessity to use gas cooling pipes of small diameters, which can lead to fouling problems. The former can in some cases be offset by using the cooling air supplied by the engine fan.

Water coolers are available in two types, the scrubber and the heat exchanger; where a water scrubber or bubbler is used, the objective is generally to cool and clean the gas in one and the same operation.

Scrubbers of many different types exist, but the principle is always the same: the gas is brought in direct contact with a fluid medium (generally water) which is sprayed into the gas stream by means of a suitable nozzle device. The advantage of this system is its small size. Disadvantages are the need for fresh water, increased complexity of maintenance, and some power consumption resulting from the use of a water pump.

The cleaning of the cooling water from phenols and other tar components is by all probability also a necessary and cumbersome operation. But so far very little experiences or cost calculations for the waste water treatment are available.

It is also possible to cool the gas by means of a water cooled heat exchanger. This is a suitable method in case a source of fresh water is continuously available and the extra investment and power consumption of a suitable water pump can be justified.

2.7 Applications of biomass gasification

A review of gasifier applications has been published by Foley and Barnard (12), who discuss the use of gasifiers for production of fuel gas for heat generation as well as the utilization of gasifiers in combination with engines.

2.7.1 Production of fuel gas

Most gasifiers in commercial operation today are used for the production of heat, rather than fuel for internal combustion engines, because of the less stringent requirements for gas heating value and tar content. The fundamental advantage of a gasifier close coupled to a burning system is its ability to produce higher temperatures than can be achieved with conventional grate, combustion, liable to slagging problems at such temperatures, and in consequence its enhancement of boiler efficiency and output.

All types of gasifiers described in Section 2.3 can provide producer gas for combustion purposes, but for the sake of simplicity up-draught gasifiers are preferred in small systems (below 1 MW thermal power), while fluidised bed gasifiers are appropriate in power ranges above this level.

Most conventional oil-fired installations can be converted to producer gas.

The most potential users of low-calorific fuel-gas in the future are expected to be found among the following industries: metallurgy, ceramic, cement, lime and pulp. In these industrial branches the conversion of kilns, boilers and driers from oil to fuel gas operation is in principal a quite simple operation.

2.7.2 Production of mechanical or electrical power in stationary installations

Gasifiers connected to stationary engines offer the possibility of using biomass to generate mechanical or electrical power in the range from a few kW up to a few MW.

Producer gas of engine quality needs a sufficiently high heating value (above 4200 KJ/m³), must be virtually tar and dust free in order to minimize engine wear, and should be as cool as possible in order to maximize the engine's gas intake and power output.

It is convenient to distinguish between applications in terms of power output. Figure 2.16 shows the power range of the various systems (36).

Figure 2.16 Application of biomass gasification processes

a) Large scale applications (500 kW and above)

This is the domain of the specialized fluidised bed or fixed bed installations.

The equipment is custom built and fully automated. Design and manufacture should be handled by specialized engineering and construction firms.

Equipment costs are likely to be in the range of US\$ 1000 per installed kW and upwards.

b) Medium scale applications (30 -500 kW)

Fixed bed equipment fuelled by wood, charcoal and some types of agricultural wastes (maize cobs, coconut shells) is offered by a number of European and US manufacturers.

Adequate and continuing demand for this type of equipment could lead to standardization of parts and designs thus lowering production costs. For the moment quoted costs are in the range of 300 - 800 US\$/kW (gasifier only) depending on type and capacity, level of automation and auxiliary equipment.

Full local manufacture is considered possible in countries possessing a well developed metal manufacturing industry. Major parts of the installations could be manufactured in most countries.

Applications are foreseen in small to medium size forestry and agro-allied industries (secondary wood industries, sawmills, coconut desiccating factories, etc.) as well as in power supply to remote communities.

c) Small-scale applications (7 - 30 kW)

This size would be appropriate for a multitude of village applications in developing countries (e.g. village maize and cereal mills, small-scale sugar crushers, looms, etc.).

The equipment must be cheap (less than 150 US\$/kW), extremely reliable and should need no special operation and maintenance skills.

Designs suitable for local manufacture are tested and produced in the Philippines (13), Tanzania (48)-and a number of other countries. Documented evidence of their success is for

the moment limited, and it should be stressed that training programmes for users and the organization of some type of maintenance service are of paramount importance.

It seems that charcoal gasifiers tend to give less operational problems in this power bracket than gasifiers fuelled by wood or agricultural residues. It is sometimes also believed that charcoal gasifier systems can be made cheaper than wood gasifiers systems in the 7 - 30 kW power range. There is some support for this in the prices charged for vehicle gasifier systems during the Second World War (43). It is not clear however if the difference of about twenty percent was caused by the difference in technology or was a result of better organized production or simply a matter of different profit margins.

d) Micro scale applications (1 - 7 kW)

This is the range Used by small and medium farmers in developing countries for providing power for irrigation systems.

Equipment must be transportable, cheap, simple and light in weight. It is quite possible that only small locally manufactured charcoal gasifiers will be able to meet the above requirements.

2.7.3 Mobile applications

The use of down-draught gasifiers fuelled by wood or charcoal to power cars, lorries, buses, trains, boats and ships has proved its value and at least one European country (Sweden) maintains plans for large-scale production in case of an emergency, (see Chapter 3). This technique is currently being studied for powering of tractors (Switzerland, France, Finland, Netherlands) as well as small vans and boats (Philippines) and lorries (Sri Lanka).

However mobile applications present a number of additional difficulties as compared with stationary units.

In the first place the construction needs to be as light as possible in order not to reduce excessively the hauling capacity of the vehicle. Because the filter installations described in Chapter 3 tend to be fairly heavy and voluminous, exacting demands are put on the engineering skills of designers of mobile equipment as well as on the choice of materials.

In the second place mobile applications tend to operate with fairly large variations in engine (and gasifier) load. Under a given set of circumstances (especially long idling periods) this can lead to tar formation and clogging of cooler/cleaners and engines, as commonly occurred during the Second World War.

Applications on trains and boats suffer less from weight and load constraints, and for this reason give better results.

Engines retrofitted with gas producers show an appreciable loss of maximum power, and it will depend very much on the geographical situation (flat or hilly terrain) as well as on the skills of the driver whether the vehicle can be operated satisfactorily.

Whether these disadvantages will be balanced by the better economy of gasifier fuelled transport vehicles depend entirely on the local situation, especially on the cost and availability of petrol and diesel oil.

2.8 Health and environmental hazards associated with the use of producer gas

A review of the different types of hazards and environmental impacts of producer gas operation has been published by Kjellström (23).

Toxic, fire and explosion hazards are the main categories.

2.8.1 Toxic hazards

An important constituent of producer gas is carbon monoxide, an extremely toxic and dangerous gas because of its tendency to combine with the haemoglobin of the blood and in this way prevent oxygen absorption and distribution. A summary of the effects caused by different concentrations of carbon monoxide in the air is given in Table 2.9.

Fortunately normal producer gas installations work under suction, so that even if a minor leak in the installation occurs, no dangerous gases will escape from the equipment during actual operation. The situation is different however during starting-up and closing down of the installation.

During starting-up the gas is generally vented, and it is necessary to ensure that the gases produced cannot be trapped in an enclosed room. As a rule a suitable chimney will provide sufficient safety.

During closing-down of the installation a pressure buildup in the gasifier will occur, caused by the still hot and pyrolysing fuel. As a result gases containing carbon monoxide will be released from the installation during a relatively short period. It is because of the danger from those gases that it is generally recommended that a gasified installation be located in the open air, if necessary covered by a roof.

Table 2.9 Toxic effects of different concentrations of carbon monoxide in the air

Percentage of CO in air	ppm	effects
0.005	50	no significant effects
0.02	200	possibly headache, mild frontal in 2 to 3 hours
0.04	400	headache frontal and nausea after 1 to 2 hours, in the back of the head after 2.5 to 3.5 hours
0.08	800	headache, dizziness and nausea in 45 min. collapse and possibly unconsciousness in 2 hours
0.16	1600	headache, dizziness and nausea in 20 minutes, collapse, unconsciousness and possibly death in 2 hours
0.32	3200	headache and dizziness in 5 to 10 minutes, unconsciousness and danger of death in 30 minutes
0.64	6400	headache and dizziness in 1 to 2 minutes, unconsciousness and danger of death in 10 to 15 minutes
1.28	12800	immediate effect; unconsciousness and danger of death in 1 to 3 minutes

There has been some dispute, deriving from Swedish experience, whether chronic poisoning can occur as a result of prolonged inhalation of relatively small amounts of carbon monoxide

which give no acute effects. It seems that the issue now has been resolved: no chronic symptoms can occur through carbon monoxide poisoning.

However this does not mean that the symptoms mentioned in Swedish literature (tiredness, irritability and touchiness, difficulty in sleeping) did not result from prolonged exposure to producer gas. There is a possibility that some other compound(s) in the gas are responsible for the symptoms.

The above stresses again the importance of placing stationary installations in an open environment as well as of taking care to avoid close contact with the gases during the starting-up and closing-down phases.

2.8.2 Fire hazards

Fire hazards can result from the following causes:

- high surface temperature of equipment;
- risks of sparks during refuelling;
- flames through gasifier air inlet on refuelling lid.

Risks can be considerably decreased by taking the following precautions:

- insulation of hot parts of the system;
- installation of double sluice filling device;
- installation of back-firing valve in gasifier inlet.

2.8.3 Explosion hazards

Explosions can occur if the gas is mixed with sufficient air to form an explosive mixture.

This could occur for several reasons:

- air leakage into the gas system;
- air penetration during refuelling;
- air leakage into a cold gasifier still containing gas which subsequently ignites;
- backfiring from the fan exhaust burner when the system is filled with a combustible mixture of air and gas during starting-up.

Air leakage into the gas system does not generally give rise to explosions. If a leakage occurs in the lower part of the gasifier (as is generally the case) this will result in partial combustion of the gas leading to higher gas outlet temperatures and a lower gas quality.

When the pyrolytic gases in the bunker section are mixed with air (as is bound to happen during refuelling) an explosive mixture can be formed. It is not unusual for this to result in small and relatively harmless explosions, especially when the fuel level in the bunker is relatively low.

Risk to the operator can be obviated if the gases in the bunker section are burnt off through the introduction of a piece of burning paper or the like, immediately after opening the fuel lid. Another possibility is to install a double sluice type filling system.

Air leakage into a cold gasifier and immediate ignition will lead to an explosion. Cold systems should always be carefully ventilated before igniting the fuel.

During the start-up of an installation, the gases are as a rule not passed through the entire filter section, in order to avoid blocking the filters with the tars produced during start-up. The filter may thus still contain air, and after an inflammable gas is produced and led through the sometimes quite voluminous - filter section an explosive mixture can result. If the gas is now ignited at the fan outlet a backfire can occur, leading to a violent explosion in the filter section. It is for this reason that it is advisable to fit the fan outlet with a water lock.

2.8.4 Environmental hazards

During the gasification of wood and/or agricultural residues, ashes (from the gasifier and from the cleaning section) and condensate (mainly water) are produced. The latter can be polluted by phenolics and tar.

The ashes do not constitute an environmental hazard and can be disposed of in the normal way. For the tar-containing condensate the situation is different, and disposal of those from a large number of gasifiers can have undesirable environmental effects. No hard data are available on the bio-degradation of the phenolic and tarry constituents of the condensates, and the problem of disposal needs careful study.

The properties of exhaust emissions from engines run on producer gas are generally considered to be acceptable, comparable to those of diesel engines.

Chapter 3 - Recent Swedish experiences with operation of vehicles on wood and charcoal gas

Sweden is today largely dependent on road vehicles using imported petroleum fuels, for transport of goods and people within the country. Roughly 90 percent of the travelling and 50 percent of the goods transport are based on the use of road vehicles.

The dependence on road vehicles is expected to remain. Since no petroleum reserves of importance have been found in Sweden, dependence on imported fuels will continue in the transport sector. Sweden is in this respect in a similar situation to many oil-importing developing countries.

It is obvious that such a large dependence on imported petroleum fuels for an important function in a modern society makes a nation very vulnerable to increased petroleum prices and to supply blockades. The need for an alternative, indigenous fuel supply for the road vehicles and farm tractors was already recognized in Sweden by the late 1930's, and it has since then been the official emergency policy to use wood and charcoal gasifiers in case of a serious supply crisis for petroleum fuels.

This policy was successfully pursued during the Second World War. Most of the road vehicles and farm tractors were then operated with either wood or charcoal gasifiers. As shown in Table 3.1 the introduction of gasifier operation was quite rapid. From less than 1000 vehicles operated on gas in 1939, the number increased to over 70000 in 1942. This rapid introduction would probably not have been possible if there had not been an active interest in the technology since the twenties with a few hundred vehicles in operation during the thirties.

The National Board for Economic Defence, which is the responsible body for emergency planning of the energy supply, still considers conversion of farm tractors, buses, lorries and passenger cars to gasifier operation to be the only realistic alternative in a sustained petroleum fuel supply crisis. Utilization of wood chip-e as fuel, rather than wood blocks and charcoal which were- used during the Second World War, is considered preferable. The reasons for this are that the fuel can be prepared with equipment already available in the paper and pulp industry and large energy losses are avoided. The utilization of wood blocks and charcoal would require investment in new equipment for fuel preparation. This would lead to economic disadvantages and delays in the introduction of the alternative fuel supply. Use of charcoal would inevitably lead to loss of more than 50 percent of the available biomass energy.

Table 3.1 Development of the producer gas vehicle fleet in Sweden 1933-1945.

Year	Number of producer gas vehicles				Number of vehicles operated on wood gas			
	Cars	Trucks	Buses	Total number of road farm vehicles tractors	Cars	Trucks	Buses	Total tractors
1933				ca. 250				
1937				ca. 100				
1939				ca. 600				
1940 Oct.	7 045	6 232	864	9 141	265	1 496	207	
1941 Apr.	14 256	27 888	2 904	45 248	3 660	12 315	1 672	
Oct.	27 197	38 035	3 638	68 872	7 344	19 018	1 965	
1942 Apr.	28 476	35 274	3 404	67 157	6 693	19 048	2 196	ca. 6 000
Oct.	33 395	35 367	3 416	72 178	6 412	19 275	2 275	
1943 Apr.	34 304	35 096	3 502	72 904	5 832	19 162	2 451	
Oct.	35 068	35 252	3 533	73 853	5 295	19 370	2 589	
1944 Apr.	32 962	34 349	3 526	70 837	4 150	18 548	2 574	
Oct.	34 116	34 916	3 531	72 663	4 006	18 721	2 645	ca. 15 000
1945 Apr.	34 854	34 799	3 339	72 992	3 807	18 775	2 725	
1946	1	3	-	4	1	1	-	1
1947	2	2	-	4	2	1	-	2

Since the biomass resources are limited - the maximum utilization of biomass fuels which can be sustained for several years with the present structure of forestry and agriculture can be estimated at some 150 TWh - and since the biomass fuel will also be needed for other purposes in the case of a petroleum supply crisis, utilization of charcoal for vehicle gasifiers will be avoided.

The Swedish interest in wood gasifiers is therefore closely related to the need felt by the Swedish Government to maintain an emergency option for the fuel supply to the transport sector. It is quite clear that wood gasifiers are a realistic alternative to petroleum fuels for rapid introduction only if there is a continuous development of the technology followed by field testing in vehicles of the types given first priority for conversion to-wood gas in case of a petroleum fuel supply crisis.

The results of this research and development work and some of the field testing will be summarized below.

The economy of using wood or charcoal gasifiers for vehicles at present prices for gasoline and diesel oil and the possibility of using this type of gasifier technology in stationary applications is discussed in the last part of this chapter. It should be pointed out, however, that the present economy is not really an issue and that the usefulness of this technology for stationary applications is probably limited to applications where the requirements for compact and lightweight systems are so important that some sacrifices in the form of a fairly short equipment lifetime and additional operator time required for fuel feeding and removal of ash and dust are accepted.

3.1 Overview of development work and testing carried out at the national machinery testing institute

3.1.1 Scope of the work

The objective of the development work, which started in 1957, has been to develop a standard type of wood gasifier system which could be made in a limited range of sizes and be used for vehicles currently operated in Sweden. Later, the development was focussed on the utilization of wood chips as fuel for the reasons explained earlier.

The development of a gasifier system for passenger cars was carried out-by the Swedish car manufacturer Volvo. The results of this work are proprietary.

The development of gasifier systems suitable for farm tractors, buses and lorries, was carried out by the National Swedish Testing Institute for Agricultural Machinery.

This work included the following elements:

1. Development of a downdraught gasifier suitable for wood chips and establishment of design rules for such gasifiers.
2. Development of a fibre glass fabric filter system for wood gas.
3. Studies of conversion of direct injection diesel engines to dual fuel operation and preparation of guidelines for conversion of such engines.
4. Field testing of a limited number of vehicles.

The results of the work carried out up to 1962 have been reported (in Swedish) by Nordstrom (33). There is no official report from the work done thereafter. In the latter part of this section, the results of the equipment development work will be summarized. The results from the field tests are summarized in Section 3.2.

3.1.2 Gasifier for wood chips

Towards the end of the Second World War, gasifiers for vehicles using wood blocks as fuel had been developed to a stage where the technology appeared to be reasonably reliable. Design rules for matching the gasifier dimensions to the size and operating conditions of the engine were fairly well established. The design rules used at that time in Sweden have been summarized in (43).

The first tests with wood chips reported by Nordstrom (33) in 1963 were made in a modified Imbert type downdraft gasifier with a V-hearth, see Fig. 3.1, with a fixed grate. The experiences were quite distressing. Bridging in the fuel bunker gave irregular flow of fuel in the gasifier. Clogging of the reduction zone leading to a large pressure drop of the gasifier appeared after less than one hour of operation. High tar content was observed for some tests.

It was soon concluded that a moving grate was necessary for wood chips to be used as fuel. The bridging problem was found to be associated with sticking of the fuel to the wall in the pyrolysis zone where some of the tars driven off from the fuel condensed and caused a sticky surface. The problem was reduced to what was considered acceptable by the

introduction of a baffle in the fuel bunker for the purpose of eliminating contact between the fuel and the walls, in the pyrolysis zone, see Fig. 3.2.

[Figure 3-1. Modified Imbert-type downdraft gasifier with V-hearth tested by Nordstrom \(33\)](#)

Figure 3.2 Sketches of standard type gasifiers for wood chips and wood blocks - a. Wood chip design

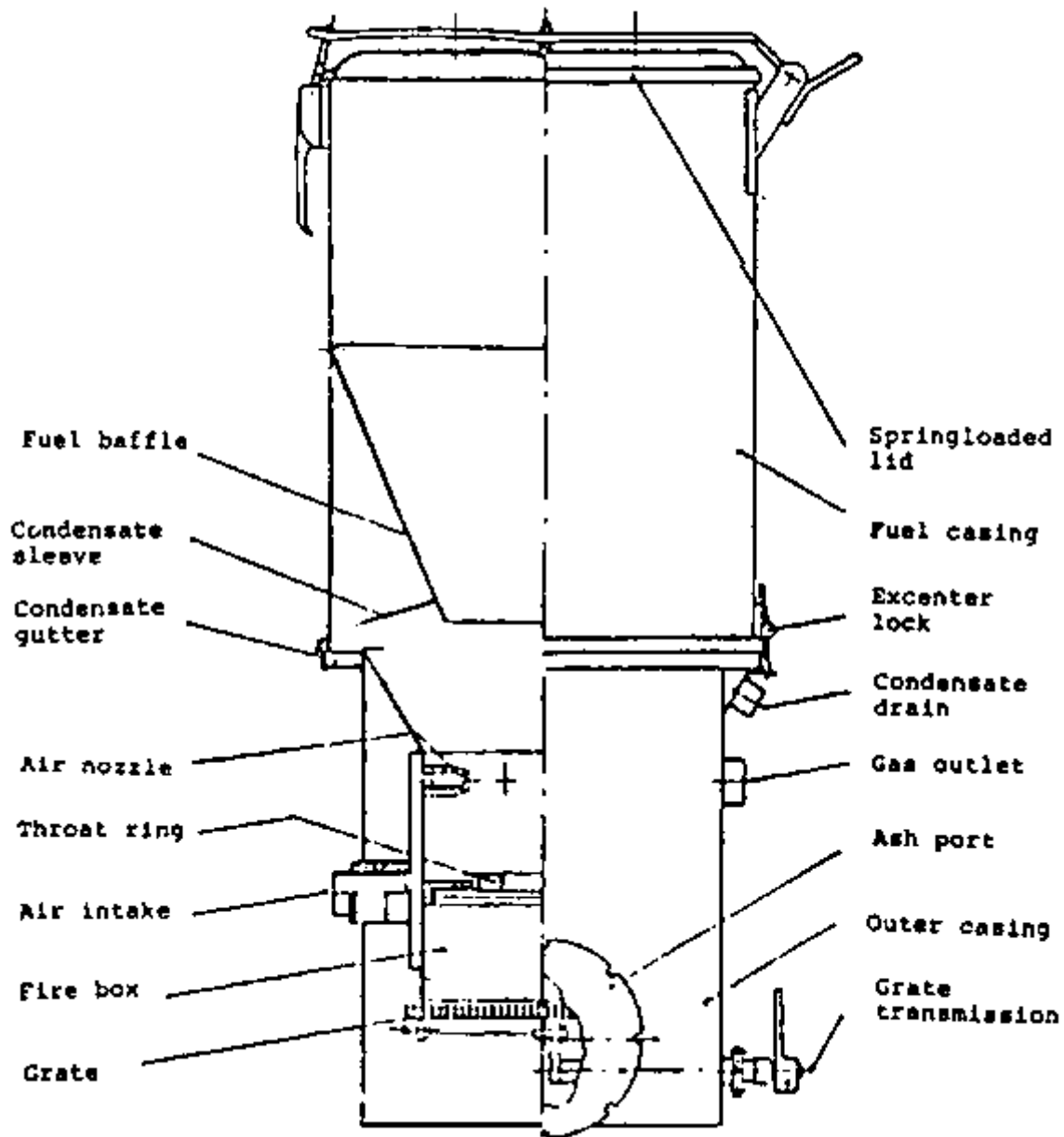
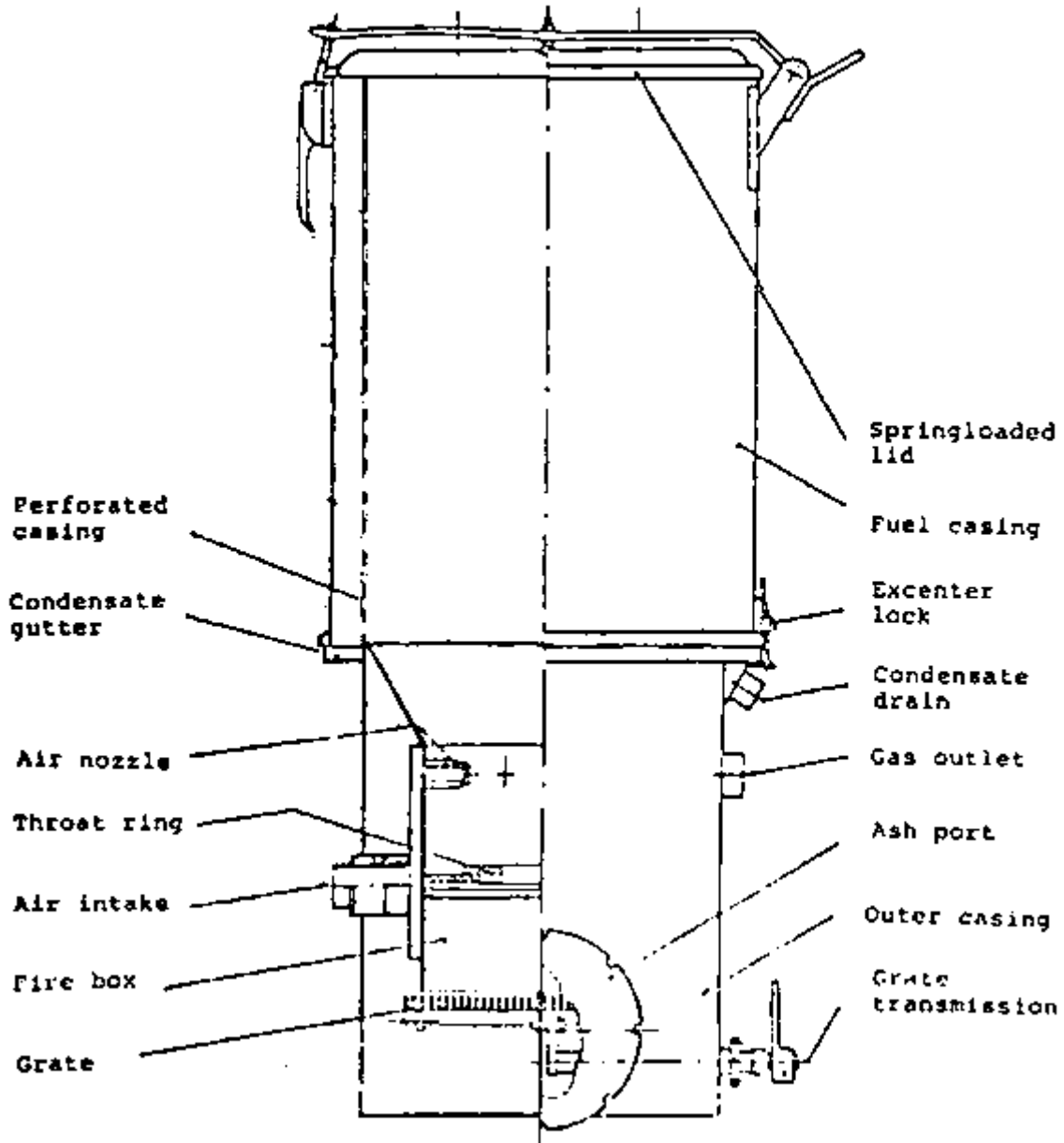

Figure 3.2 Sketches of standard type gasifiers for wood chips and wood blocks - b. Adaptation for wood blocks



The main dimensions of the three standard sizes of gasifiers, each with four combinations of choke plate and nozzle sizes, are shown in Table 3.2 and Fig. 3.3.

In comparison with the design guidelines for wood block gasifiers presented in Chapter 2, the maximum "hearth load" B defined as the superficial velocity of gas through the narrowest section of the gasifier is generally slightly higher, i.e. about 1.0 m /cm h., and the turn-down ratio higher, i.e. about 6 - 9. The dimensions of the standard designs for wood chip gasifiers show the following differences from the recommendations in Chapter 2.

- The number of air nozzles is generally larger.
- The ratio of the nozzle area to the throat area varies in somewhat different ways for the three standard sizes of the firebox, see Fig. 3.4.a.
- The ratio of the firebox diameter to the throat diameter d/d is generally higher than recommended for wood blocks.

- The ratio of the nozzle tip diameter to the throat diameter d_t/d is generally greater than recommended for wood blocks.

- The height of the reduction zone is much less than the average of 32 cm for wood block gasifiers and for the smallest sizes even below the minimum height of 20 cm recommended in Chapter 2 for wood blocks.

Other features of the standard gasifiers for wood chips are that the gas is brought out of the gasifier at about the throat level and that the outer surface of the upper part of the gasifier acts as a cooling surface for condensation of water and tars. The condensate is drained into a separate vessel located close to the gasifier.

The main advantage of this system is that it is possible to drain-off condensates which form after shut-down of the operation when the gasifier cools off. The condensate may otherwise wet the charcoal bed in the fire-zone and cause difficulties to re-ignite the gasifier. There will also be some drying of the fuel as indicated by tests reported by Nordstrom (33). According to these, 60 - 80 percent of the moisture in the wood fed into the gasifier can be drained off from the condensate jacket.

Table 3.2 Main dimensions of standard type gasifiers for wood chips

Gasifier type	Main dimensions of the hearth and reduction zones							Gas production Nm^3/h		Wood consumption at max. load kg/h
	d_h	d_t	h_{nt}	h_r	n	d_n	l_n	Max.	Min.	
F-3	310	60	115	175	6	7.0	50	25	4	12
60-120	310	80	125	165	6	8.0	50	50	6	25
F-300	310	100	135	155	6	9.5	40	80	8	35
60/120	310	120	145	145	6	11.5	40	115	12	50
F-5	370	80	125	205	7	9.0	60	60	7	25
80/150	370	100	135	195	7	10.0	60	80	10	35
F-500	370	125	145	185	7	11.0	50	120	13	55
80/150	370	150	155	175	7	12.0	50	165	18	75
F-7	430	110	140	275	9	9.5	70	105	13	50
110-180	430	130	150	265	9	10.5	70	135	17	60
F-700	430	155	160	255	9	12.0	50	170	22	80
110/180	430	180	170	245	9	14.0	50	220	28	100

Dimensions of the fuel container (mm)				
d_B	627	627	627	720
h_B	790	930	1270	1450
h_1	340	480	820	900
h_2	220	360	700	610
total volume dm^3	155	199	304	401

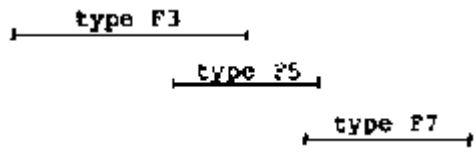

Figure 3.3 Main dimensions of standard type gasifiers for wood chips

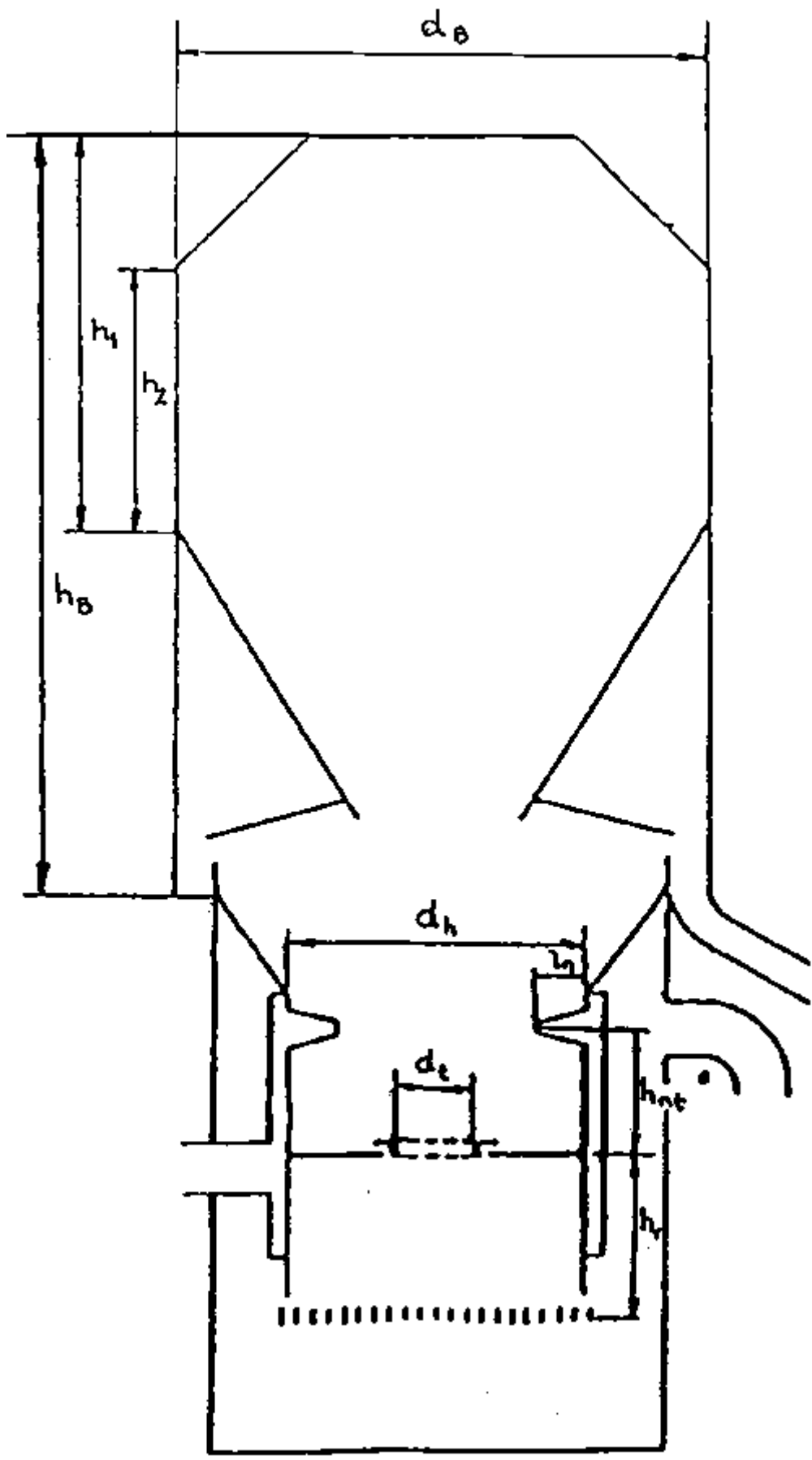

Figure 3.4 Design guidelines for down-draft gasifiers - a. Ratio between nozzle flow area, A_n , and throat area, A_t , as a function of the throat diameter.

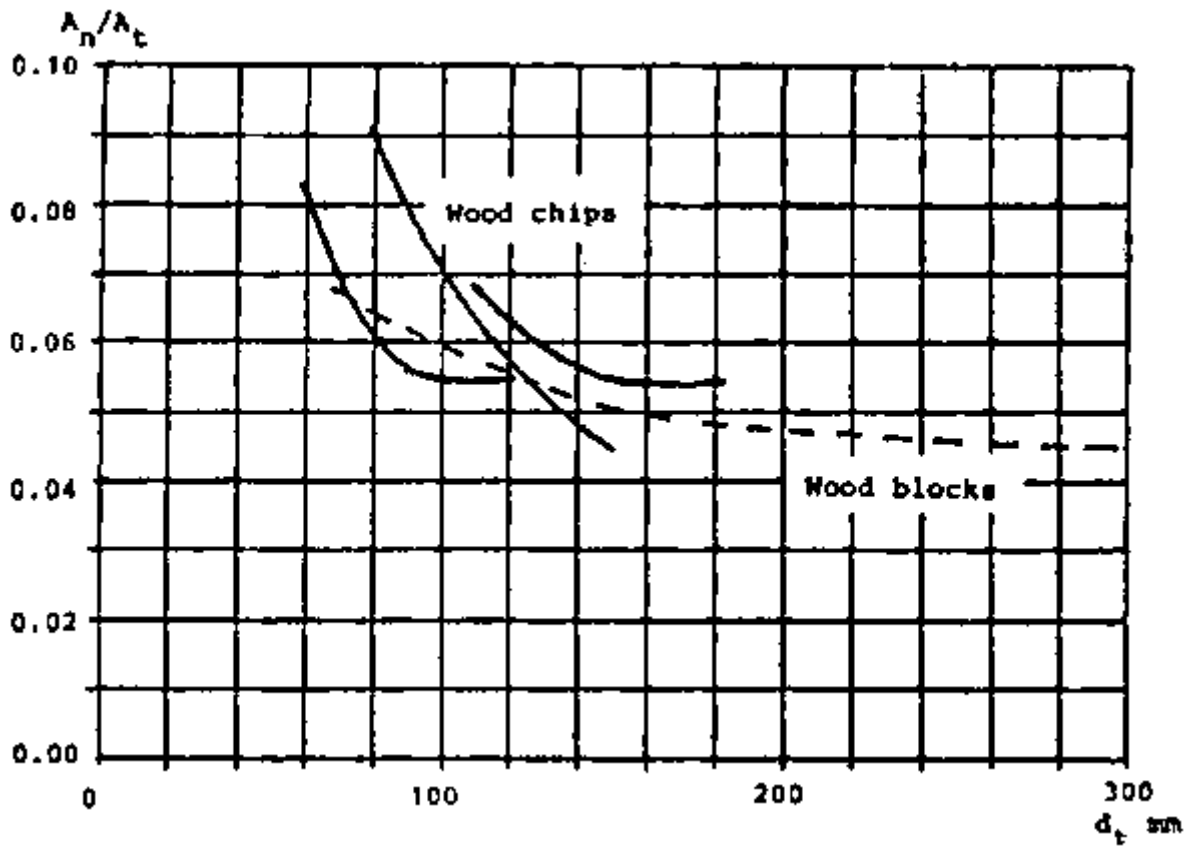

Figure 3.4 Design guidelines for down-draft gasifiers - b. Diameter of the fire box, d_r , as a function of the throat diameter, d_t .

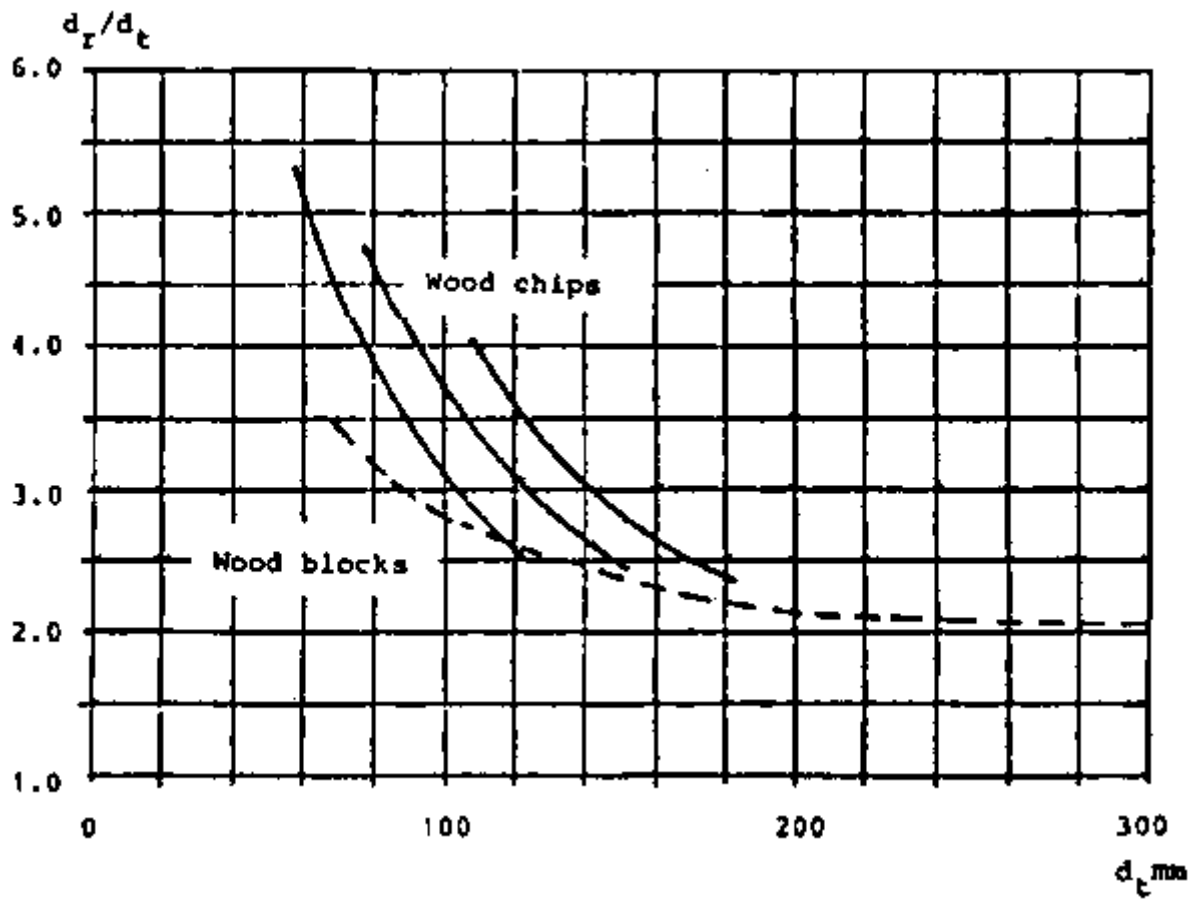

Figure 3.4 Design guidelines for down-draft gasifiers - c. Nozzle tip ring diameter, d_{nt} , as a function of the throat diameter, d_t .

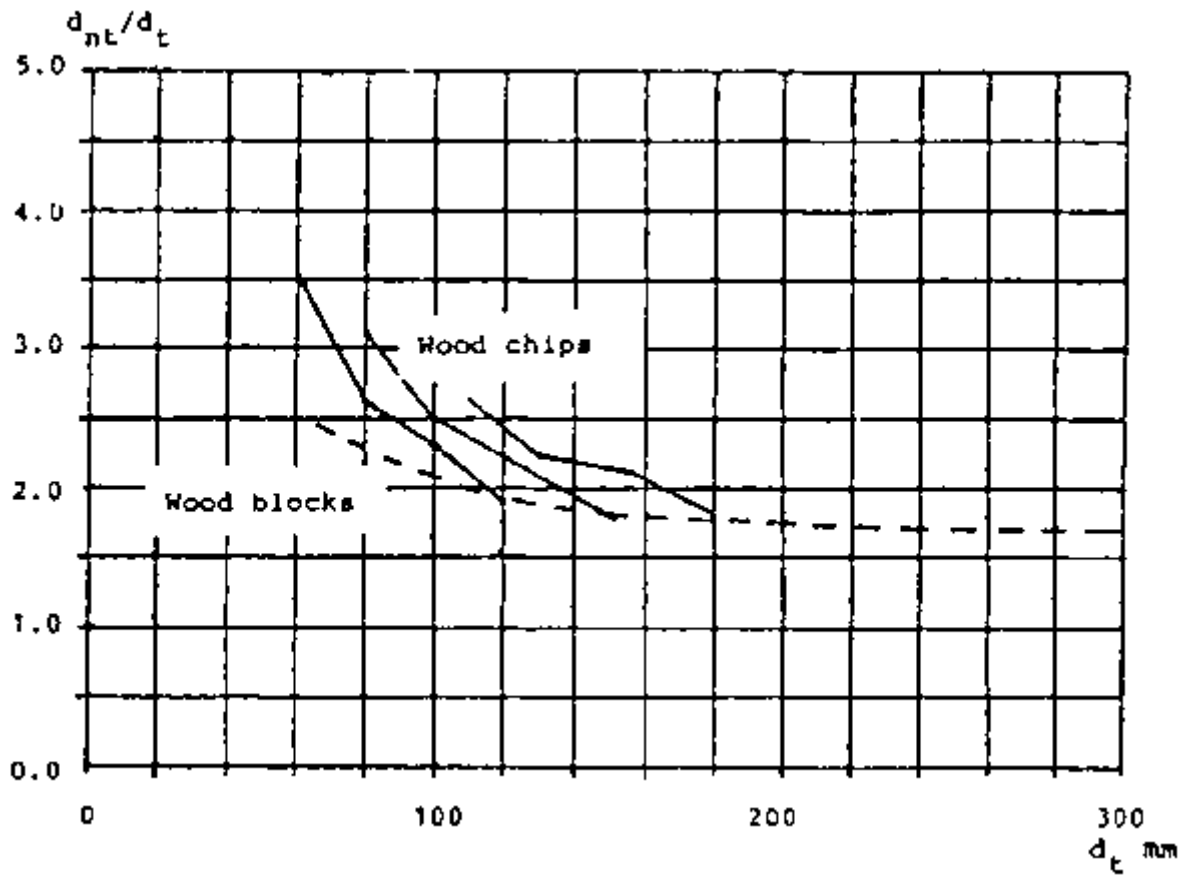
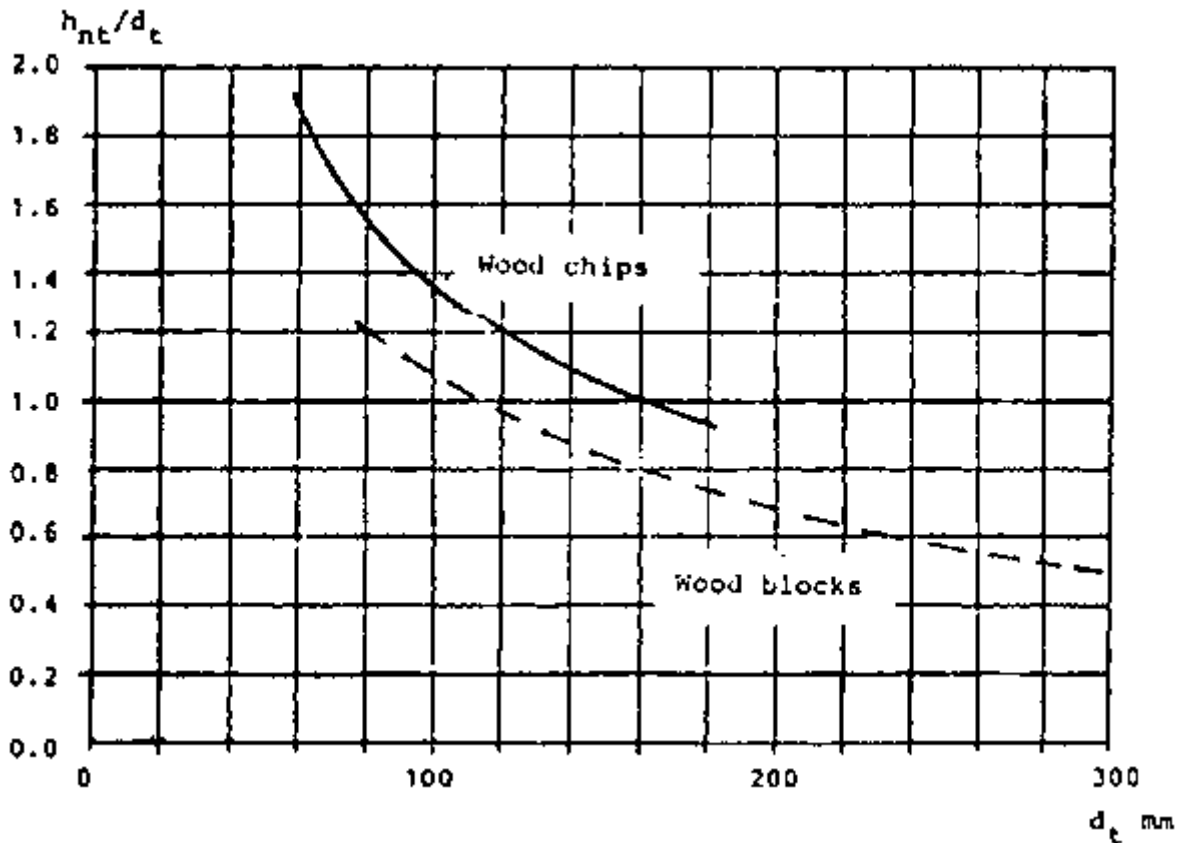

Figure 3.4 Design guidelines for down-draft gasifiers - d. Height of the nozzle plane above the throat, h_{nt} , as a function of the throat diameter



The throat section is built-up by a loose throat ring resting on a support ring which can be placed at different levels below the nozzle tip plane by variation of the number of distance rings between the support ring and the brackets welded to the fire-box wall. This throat ring can easily be changed to adapt the gasifier to new operating conditions, and it can also easily be replaced if damaged by overheating.

The overall cold gas efficiency of this type of gasifier defined as:

$$\eta_g = \frac{q_{Vg} \times H_{ig}}{q_{Mf} \times H_{if}}$$

where

- η_g = overall cold gas efficiency
- q_{Vg} = gas volume flow
- q_{Mf} = fuel mass flow
- H_{ig} = lower gas heating value
- H_{if} = lower fuel heating value

has been determined as about 70 percent over a load range from 100 per cent to 20 percent. The tar content of the gas has been determined between 0.04 and 0.20 g/m³ over the practical load range. The tar content can be compared with the guidelines given by Tiedema et al (42) according to which the tar content should be less than 0.5 g/m³ if the gas is to be suitable as fuel for an internal combustion engine .

3.1.3 Fibre glass fabric filter system

The gas cleaning for a typical wood gasifier system used in the Second World War was accomplished by a cyclone, a gas cooler with some scrubbing action and a packed bed filter, see Fig. 3.5a.

Systematic tests with this type of gas cleaning system have been reported by Nordström (33) according to which deposits were accumulated in the gas-air mixer and the inlet manifold at a rate of 1 - 2 g/h. The engine wear and the contamination of the lubrication oil exceeded considerably those observed on diesel fuel operation.

After considering several possibilities for improved gas cleaning systems such as fabric filters, electrostatic filters and wet scrubbers, fabric filters using a glassfibre cloth as filtering material were selected as most suitable for vehicle applications.

Figure 3.5 Gas cleaning systems for vehicles tested by Nordstrom (33) - a. Traditional wet cleaning system

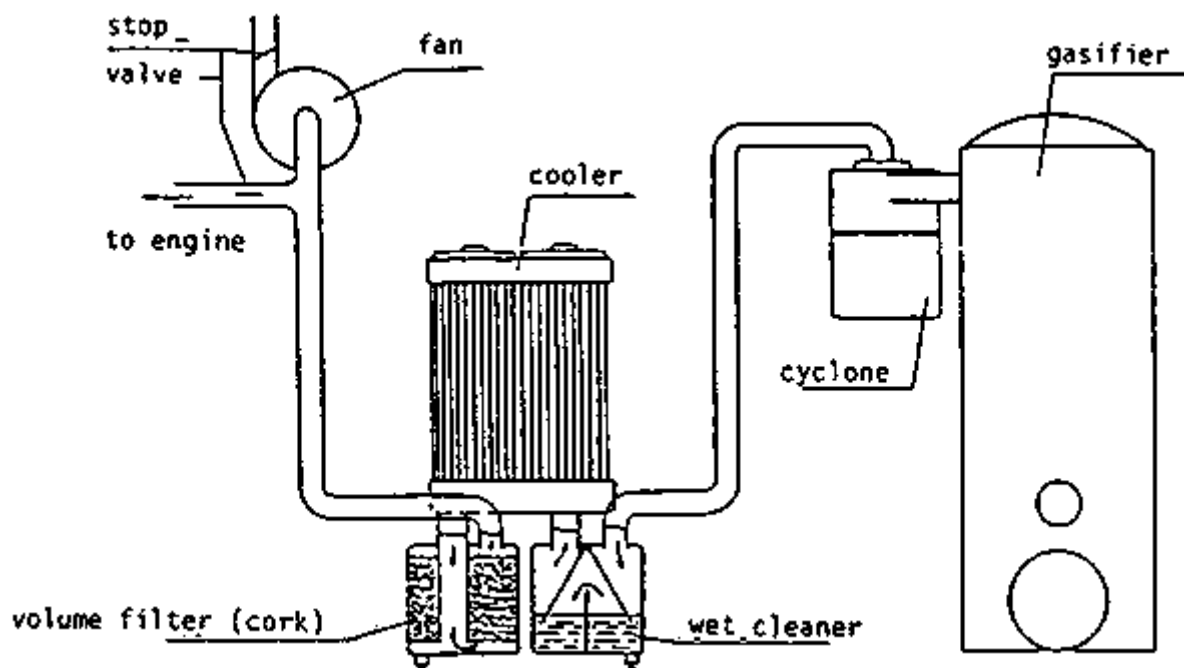

Figure 3.5 Gas cleaning systems for vehicles tested by Nordstrom (33) - b. Fabric filter cleaning system with cyclone.

Glass-fibre cloth has a maximum operating temperature of about 300°C, which means that it is possible to operate the filter at a temperature giving a large margin over the dew-point of the gas. This is 45-60°C when wood with a moisture content of 20-35 percent is used as fuel. Operation of a fabric filter with condensation in the filter leads to a very high pressure drop across the filter and consequently a reduced power output of the engine.

To study engine wear and contamination of the lubricant oil comparative tests with wood gas operation using a fabric filter cleaning system, Fig. 3.5b, and diesel fuel operation were carried out with three farm tractors in field conditions. It was found, see Table 3.3, that the cylinder wear was considerably less than for the old type of cleaning system and in some cases even less than for operation on diesel fuel. A similar result was found for contamination of the lubricant oil. Dust concentrations after cleaning were 0.3 mg/m³ with the fabric filter system, as compared with 200 - 400 mg/m³ for the wet cleaning system. It can be

observed that Tiedema et al (42) consider that less than 50 mg/m³ is acceptable, and less than 5 mg/m³ is preferred.

After tests with different filter configurations, a standard filter box, see Fig. 3.6, was designed in which 8 filter bags giving a total filter surface of 3.0 m are placed. The box is insulated with 10 mm thick layer of mineral wool. The weight of a complete filter box is 65.5 kg.

It is recommended that the maximum gas flow through one filter box shall be less than about 65 m³/h, giving an equivalent velocity through the filter fabric of 0.01 m/s at the operating temperature of 200°C.

The pressure loss over the filter depends on the load, and the amount of dust in the filter. If condensation occurs in the filter, and the fabric gets wet, the pressure loss will increase considerably.

For dry fabric with a normal dust layer, the pressure loss will vary with the load, approximately as in Table 3.4.

Practical tests with a truck (Scania Vabis L75, see Table 3.11), to study the increase of pressure loss with dust accumulation, show that for driving at 60 km/h on a flat road with clean filter bags, the pressure loss was about 150-200 mm Wg up to 500 - 750 km (i.e. 8 - 12 h). The pressure loss then increased by 60 - 75 mm Wg per 1000 km. After 3000 km (i.e. 50 h) the pressure loss had increased to twice the value for clean filter bags.

Table 3.3 Experiences with different gas cleaning systems reported by Nordström (33)

Tractor number	01	02	03	06	08
<u>Cylinder wear tests</u>					
Straight diesel operation (similar type of tractor) mm/1000 h	0.016	0.028	0.031	0.005- 0.010	0.020
Producer gas/diesel operation Old type of cleaning system (Fig. 3.5a)					
Test period, h	910	1540	420		
Wear mm/1000 h	0.05	0.05	0.06		
Producer gas/diesel operation Fabric filter cleaning system (Fig. 3.5b)					
Test period, h			1440	1860	1860
Wear mm/1000 h			0.007	0.019	0.011
<u>Oil contamination (expressed as amounts of insoluble products in benzene after 100 h)</u>					
Straight diesel operation		0.2 - 0.3 %			
Producer gas/diesel operation, old type of cleaning system		0.54 - 1.97 % (average 0.75 %)			
Producer gas/diesel operation, fabric filter cleaning system					0.12 %

The cleaning interval in practical operation is determined by how much power loss, resulting from pressure drop in filter, the driver is willing to accept. Normal cleaning intervals range between 1500 and 3000 km.

Measurements of pressure losses caused by condensation in the filter bags, see Nordstrom (33) show that the moisture may increase the pressure drop by a factor of over 6. In order to

avoid condensation, the gasifier should be operated with the starting fan until the gas temperature at the outlet of the gasifier is about 250°C. This may require fan operation for 15 - 20 minutes, depending on-the ambient temperature.

Table 3.4 Pressure loss over fabric filter

Gas flow m ³ /hm ²	Pressure loss mm Wg <u>1/</u>
10	130
20	250
30	380
40	500

1/ mm H₂O measured with a water gauge

3.1.4 Conversion of diesel engines to producer gas operation

a) Conversion to spark ignition

Detailed studies of conversion of two diesel engines from Swedish manufacturers, Volvo and Bolinder-Munktell, to spark ignition for operation on straight producer gas were carried out in 1957-1963 and have been reported by Nordstrom (33).

The modifications included replacement of the cylinder head to allow fitting of spark plugs, replacement of the injection pump by a distributor, and use of special producer gas pistons giving a lower compression ratio. Different shapes of the combustion chamber were tested on one of the engines.

Table 3.5 gives a summary of leading data and performance of the two engines studied. The conversion cost for the engine only, recalculated to the 1984 US dollar rate was found to be about 40 - 50 \$/kW. I

Table 3.5 Data and performance of two diesel engines converted to spark ignition for straight producer gas operation

Engine type	Volvo D47	Bolinder-Munktell BM 1113
No. of cylinders	6	3
Displacement volume dm ³	4.7	3.78
Cylinder diameter mm	95	111
Stroke length mm	110	130
<u>Diesel operation</u>		
Compression ratio	17.1	16.5:1
Max power kW	71	42
rpm at max power	2800	2200
<u>Producer gas operation</u>		
Compression ratio	7.6:1	10:1
Max power kW	34	19.6
rpm at max power	2200	2200
Power output relative to straight diesel operation at different speeds		
<u>rpm</u>		
800	20%	12%
1500	31	18
2000	38	21 <u>1/</u>
2500	45	

1/ The efficiency is surprisingly low compared to the reported maximum power output at 2200 rpm

Figure 3.6 Sketches of the standard type fabric filter

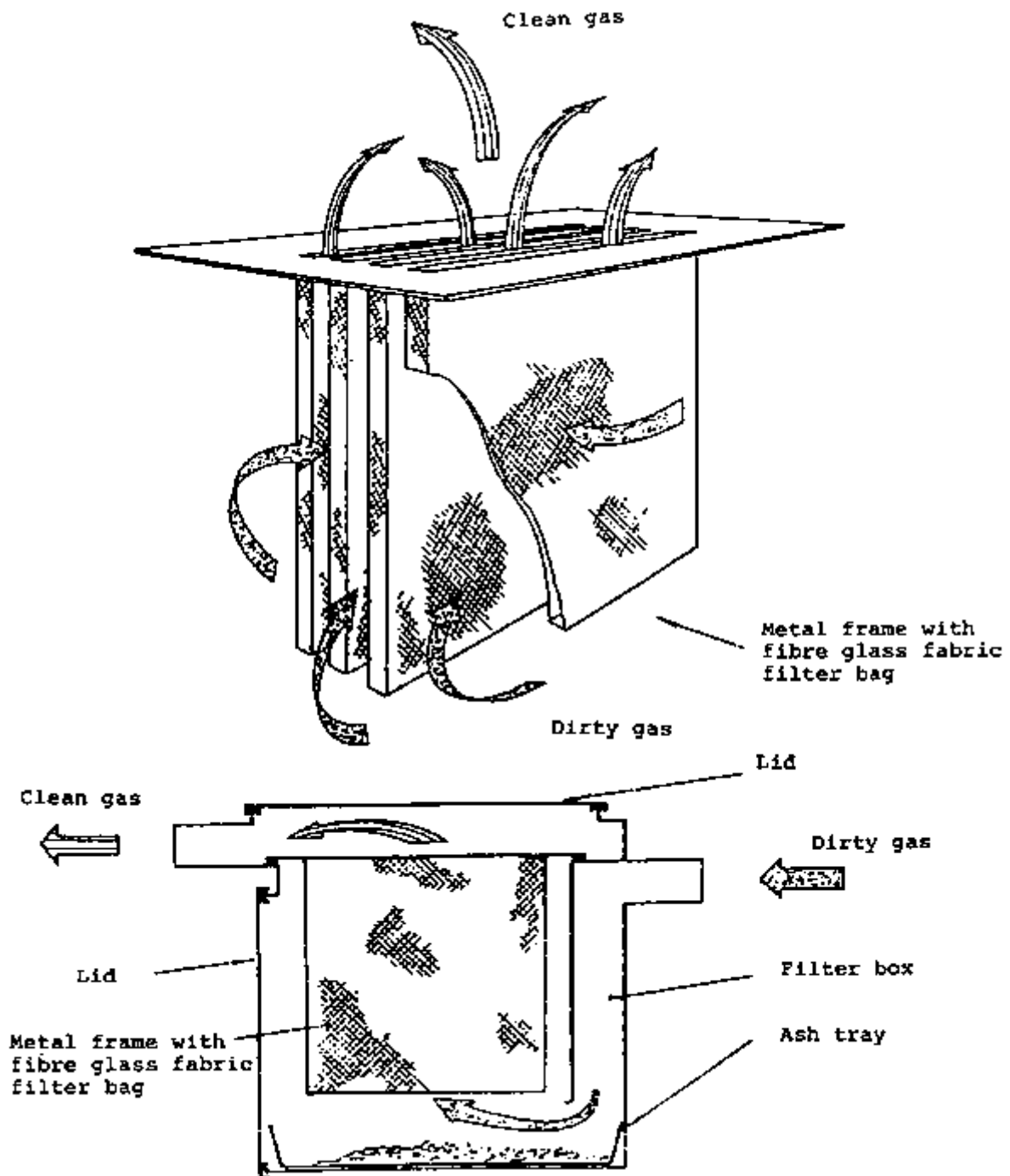

b) Dual fuelling of pre-chamber and swirl chamber diesel engines

Tests with dual fuel operation of one pre-chamber and one swirl chamber diesel engine have been reported by Nordström (33). The tests indicate that these engines are not suitable for dual fuel operation, since too early ignition of the gas/air mixture, leading to diesel-knocking, will occur unless the load is fairly low or the gas/air mixture is clean, leading to a moderate diesel oil substitution.

c) Dual fuelling of direct injection engines

Studies of the performance of direct injection diesel engines operated in a dual fuel mode with a minimum diesel oil injection, have been carried out at the National Swedish Testing Institute for Agricultural Machinery. The tests are still going on. A list of the tested vehicles is given in Tables 3.10 and 3.11.

The experience is that the modifications required are generally simple and limited to:

- installation of a control lever for obtaining low injection quantities and maintaining the possibility for normal injection by straight diesel operation;
- modification of the injection pump to provide suitable injection characteristics (constant injection per stroke at varying engine speed);
- advancing the injection timing.

The direct injection engines will normally operate well in dual fuel mode with a compression ratio of 1:16 to 1:16.5. Diesel knocking may occur in some cases. The compression ratio must then be reduced by use of double cylinder head gaskets. The reduction of the injection amount is accomplished for in-line pumps by mechanically constraining the movement of the control rod.

Suitable injection characteristics for such pumps are obtained by use of a specially designed delivery valve, see Nordstrom (33). For distributor pumps, the flow is reduced by adjustment of the metering valve. Distributor pumps may suffer from inadequate cooling and lubrication if the injection flow is reduced since there will be a very small supply of cold fuel to the pump. This can be remedied by leading the excess flow from the pump to the fuel tank rather than recirculating it to the filter, see Fig. 3.7. Depending on the injector design it may be necessary to modify the mounting of the injectors or to replace the injectors in order to avoid coking as a result of high injector temperature caused by the low injection flow. An example of such modification is given in section 3.2.2.

The studies of the effects of injection timing on power output indicate that the injection timing is not very important for engine speeds below 1200 rpm, and that advancing the injection timing grows more important as the speed increases. Injection advancement beyond 35 - 40° was observed to give pressure fluctuations.- Compromises between maximum power at high rpm and disturbance free combustion at low rpm may be necessary. It is recommended that the injection timing setting for dual fuel operation be determined by bench-tests for each type of engine.

Table 3.6 shows examples of performance data determined in laboratory tests for two direct injection engines operated on dual fuel. The full power efficiency of the engines is about 35 percent. The diesel oil substitution is between 80 percent and 90 percent.

The power loss in dual fuel operation was found to be 10 - 38 percent, see Tables 3.10 and 3.11.

3.1.5 Tests with different fuels

a) Fuel specifications

The practical tests with gasifiers for wood chips developed at the National Swedish Testing Institute for Agricultural Machinery have been carried out with fuel moisture contents (wet basis) of 10 - 20 percent. The upper limit for the moisture content for acceptable gas quality

is specified as 30 percent. If the moisture content of the fuel exceeds about 40 percent, the gas will not be combustible.

The size distribution for wood chips may vary depending on the characteristics of the chipper. Long sticks may cause bunker flow problems. It is recommended that the chips be screened to remove fines (below 10 x 10 mm) and coarse pieces (max. size about 6-0 mm). A typical size distribution of suitable wood chips is given in Table 3.7.

Tests have been run with a gasifier type F5 mounted on a tractor to study the effect of the size distribution on the maximum power output. The results are summarized in Table 3.8.

Table 3.6 Results of performance tests for direct injection engines operated in dual fuel mode.

Engine speed	Power output	Specific fuel consumption		Efficiency	Diesel oil fraction of fuel
		Producer gas	Diesel oil		
rpm	kW	m ³ /kWh	g/kWh	%	%
Truck, Scania Vabis L5150					
Cylinder volume 6.2 dm ³ , compression ratio 16:1					
<u>Full power test</u>					
1000	36.7	1.63	19.1	36.0	8.3
1200	43.2	1.63	23.2	35.6	10.0
1400	49.6	1.63	26.3	35.0	11.1
1600	55.5	1.61	28.8	34.9	12.2
1800	60.2	1.65	30.8	33.8	12.7
2000	62.8	1.75	32.5	32.0	12.6
2200	64.6	1.84	34.0	30.5	12.6
Tractor, Fordson Power Major					
Cylinder volume 3.6 dm ³					
<u>Part load test</u>					
1600	29.6	1.64	48.0	32.5	19.0
1800	25.1	1.67	57.3	30.8	21.6
1840	22.2	1.80	64.0	28.3	22.1
1890	14.8	2.40	84.0	21.2	21.8
1920	7.4	4.00	183.0	12.0	26.8

Figure 3.7 Modification of the fuel system for dual fuel operation

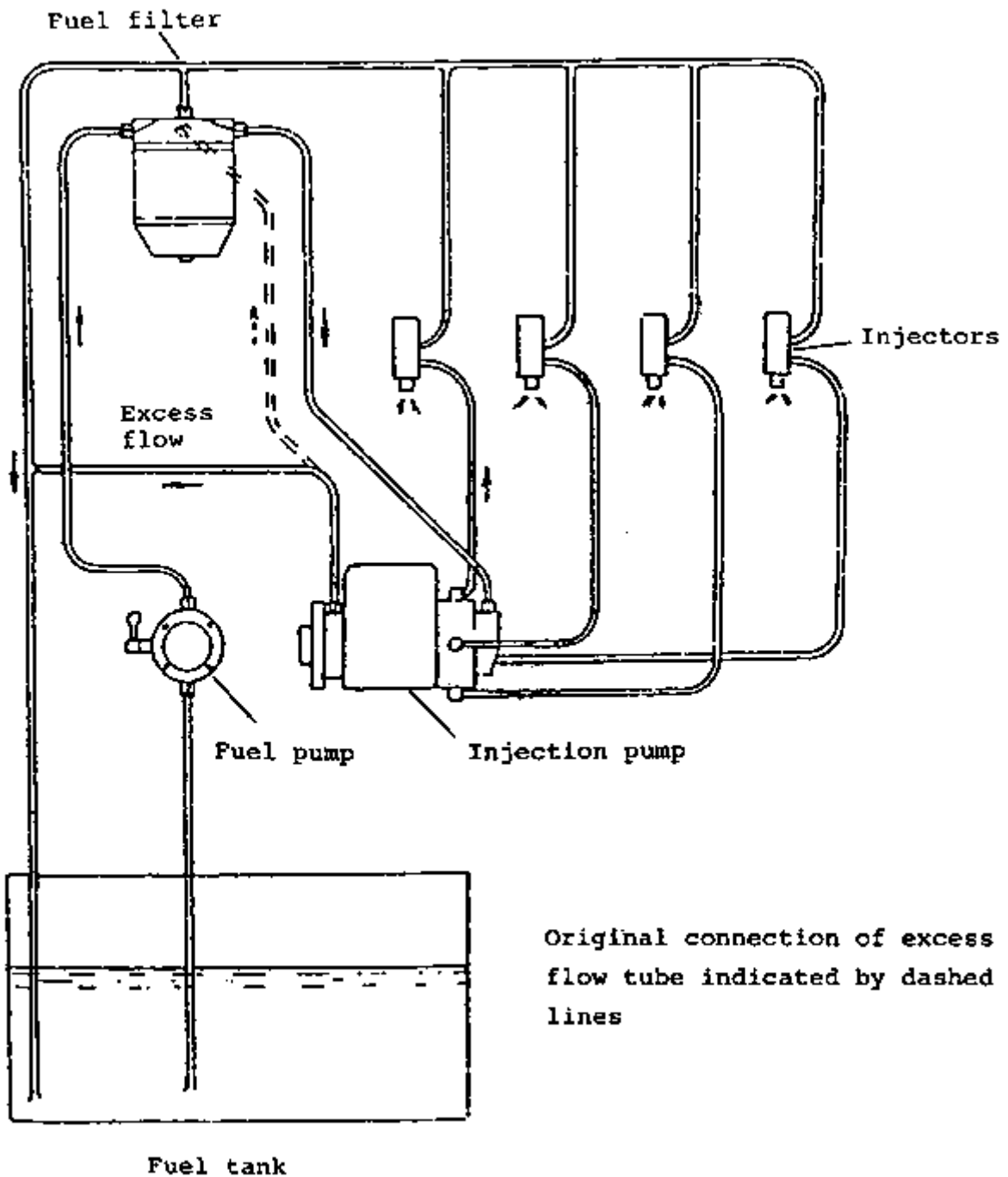

The power increase can partly be explained by reduced pressure losses in the gasifier. It appears that in these tests the gas quality was also improved when the fines were removed, since less than 50 percent of the power increase can be explained by reduced pressure losses.

According to these tests, removal of the fines (below 5 mm) gives a substantial power increase at a fairly small expense, i.e. about 3 percent increase of the feedstock cost. Screening for removal of material in the range 5 - 10 mm may also be considered worthwhile, whereas further screening does not appear to give any power increase.

Table 3.7 Typical size distribution for wood chips suitable for vehicle gasifiers.

Size range	% weight
Below 5 x 5 mm	2 - 3
5 x 5 - 10 x 10	6 - 11
10 x 10 - 15 x 15	12 - 19
15 x 15 - 20 x 20	20 - 24
20 x 20 - 25 x 25	25 - 30
25 x 25 - 30 x 30	9 - 20
30 x 30 - 35 x 35	about 5
35 x 35 and above	about 3

Table 3.8 Improvement of maximum power output by screening of wood chips

Size range	Unsieved chips	5-40 mm	10-40 mm	15-40 mm
Sieving loss %	-	3	14	34
Pressure drop across gasifier bar	0.18	0.13	0.09	0.08
Power output at 1800 rpm kW	16.8	18.1	21.1	21.0
Power increase by sieving %	0	7.7	25.5	25.5

b) Use of wood blocks

The gasifier for wood chips can easily be converted to use of wood blocks by replacing the conical screen by a perforated cylinder, see Fig. 3.2. The power output will be improved by at least 10 per cent when wood blocks are used, as a result of the reduction of pressure losses in the gasifier.

c) Use of other fuels

Scoping tests with biomass fuels other than wood blocks and wood chips in these types of gasifiers have been carried out in order to provide a basis for assessment of the needs for further research and development in case such other fuels are to be used in some applications.

Table 3.9 summarizes the results of these tests, some of which have been reported in detail by Höglund (18). Of the tested fuels, only coconut shell showed a performance similar to or better than wood chips. Milled peat, wheat straw cubes, and pressed sugarcane appeared to be unsuitable.

It appears that with rape straw pellets, wet carbonized peat pellets, sod peat and probably also coconut husk, opening of the gasifier for removal of slag may be required every 6 - 8 hours of operation. This can be done in 30 - 45 minutes and this frequent cleaning may be acceptable in some applications. If so, it appears possible to use these fuels if some loss of power is accepted. If frequent cleaning of the gasifier is not acceptable, the gasifier design must be modified to eliminate the slugging problem. Studies on these lines are at present being carried out by the Beijer Institute.

3.2 Experiences gained from conversion and operation of modern vehicles

.2.1 The need for continued practical tests

Producer gas was used as a substitute fuel for almost all the vehicles operated in Sweden during the Second World War. Some improvements of the gasifier and the gas cleaning technology have been made since then. This does not necessarily mean that producer gas is still a realistic option for substitution of petroleum fuels in case of a supply crisis. The current engines are different from those used in the forties and so are the vehicles. For an assessment of the present possibilities of producer gas, it is therefore important to collect and evaluate experiences from operation of modern vehicles with this fuel. Tables 3.10 and 3.11 list tractors and trucks converted to producer gas in Sweden after the Second World War. The majority have been converted and tested by the National Swedish Testing Institute for Agricultural Machinery, and have been used for practical operation for several years, monitored by the Institute. These tests have been concentrated on dual fuelling of compression-ignition engines. The operating experience now covers more than 65000 km for trucks and 15000 hours for tractors.

Table 3.9 Results of scoping tests with various biomass fuels in the standard gasifier for wood chips

Fuel tested	Testing vehicle	Experiences	Conclusions
<u>Peat</u>			
Pellets of wet carbonized peat	Scania L80 Gasifier F500	Distance covered 224 km. Large pressure drop in gasifier. Slagging at air nozzles, tar clogging of fabric filter.	Tar problem might be eliminated by other choice of nozzles and choke plate.
Sod peat	Scania L80 Gasifier F500 (wood block configuration)	Distance covered 735 km. Slagging. Clogging of perforated fuel casing and condensate jacket. Fabric filter needs more frequent cleaning than with wood chips.	If frequent cleaning of gasifier and filters acceptable, the fuel may be used.
Milled peat	Scania L80 Gasifier F500	Gas hardly combustible. Large pressure loss after a few km. Engine very weak.	This fuel is not possible to use in present gasifier.
<u>Agricultural residues</u>			
Rape straw pellets	Scania L80 Gasifier F500	Distance covered 445 km. (8.5 h). Large slag-cake formed.	If frequent cleaning of gasifier is acceptable, the fuel may be used.
Wheat straw cubes	Tractor: Bolinder-Munktell, BM650 Gasifier F300 (Original configuration).	4.5 h of operation. Bridging and severe slagging. Power output 66-82% of that for wood chips.	This fuel is not suitable for the present gasifier.
	Tractor: Bolinder-Munktell, BM650 Gasifier F300 (wood block configuration).	4 h of operation. Some bridging and severe slagging. Power output 78-90% of that for wood chips.	
Sugar cane, pressed and	Tractor: Bolinder-Munktell BM650	3 h of operation. Bridging caused irregular gas production.	The fuel is not suitable in this form for the present gasifier.

cut	Gasifier F300	Some slagging. Power output 97% of that for wood chips.	
Coconut shell crushed	Tractor: Bolinder-Munktell BM650 Gasifier F300	7 h of operation. Excellent performance. Power output 103% of that for wood chips.	Good fuel for the present gasifier.
Coconut husk, cut	Tractor: Bolinder-Munktell BM650 Gasifier F300 (wood block configuration).	2.5 h of operation. No bridging, but some slagging observed. Power output 102% of that for wood chips.	Test too short for conclusion. Absence of bridging is promising. Slagging indications shows that more frequent cleaning of gasifier may required.

Table 3.10 Tractors converted to producer gas operation in Sweden after the Second World War

Type of vehicle	Engine data				Producer gas fuel	Fuel consumption		Operating record h
	Ignition system	Cylinder volume (dm ³)	Compression ratio	Power output kW Original After conversion		Solid kg/h	Liquid l/h	
Tractors								
Bolinder Munktell BM 33	C.I.	1.4		28 23	Wood blocks	12 - 16	0.5 - 1.15	
David Brown 330	C.I.	1.5		20.2 19	-	4 - 10	0.5 - 1.15	
Fordson Major	C.I.	1.6		29 27	"	12 - 15	0.5 - 1.1	
Fordson Power Major	C.I.	1.6		34 27	"	12 - 15	0.15 - 1.15	
Mulfield DM 4	C.I.	1.4		29 24	"	11	0.87	
Bolinder Munktell BM 350	C.I.							5 413
Ford 5000	C.I.	1.8		43 33				1 980
Hobby Ferguson MF 1100 (1948)	C.I.	1.8	16.1	44 51		12	2.2	2 830
Bolinder Munktell BM 350 (1971)	C.I.	1.2	16.1	40 30	Wood blocks			2 600 2/
Bolinder Munktell BM 650 (1971)	C.I.	1.2	16.1	40 30	Wood chips	12 - 14	2.4	1 580

1/ C.I. Compression ignition. S.I. Spark ignition.
 2/ Still in operation

Table 3.11 Trucks converted to producer gas operation in Sweden after the Second World War

In addition, the Institute has converted and operated one passenger car, an Opel Rekord 1700, which has been driven for more than 47000 km with a wood chip gasifier. The Swedish car manufacturer Volvo has converted and operated three passenger cars, one Volvo 142 and two Volvo 144, with engine types B20.

Recent conversions of trucks have been made by the Beijer Institute for field tests in developing countries and by a private company.

The most comprehensive operating record for modern tractors and trucks has been collected within the programme conducted by the National Swedish Testing Institute for Agricultural Machinery. It's experiences with two of these vehicles, a truck and a farm tractor are presented below.

Field tests with each particular vehicle model and for all operating conditions are obviously necessary for a complete assessment of producer gas as a vehicle fuel. The experiences described can serve only to provide some guidance as far as the technical performance, service and maintenance requirements and equipment lifetime are concerned.

The experiences are not related to the most recent models of vehicles and are not necessarily transferable to the operating conditions of other countries. The field tests in developing countries planned by the Swedish International Development Authority and other international development assistance organizations will provide valuable complementary information.

3.2.2 Conversion and operation of a Massey Ferguson 1100 farm tractor

a) General description of the converted tractor

The experiences from the conversion of this tractor have been reported (in Swedish) by Axelsson (1).

Table 3.12 gives the main data for the converted tractor. The gasifier system is shown in Fig. 3.8, and a picture of the converted tractor in Fig. 3.9.

Figure 3.8 Schematic of the gasifier system used for a Massey Ferguson farm tractor

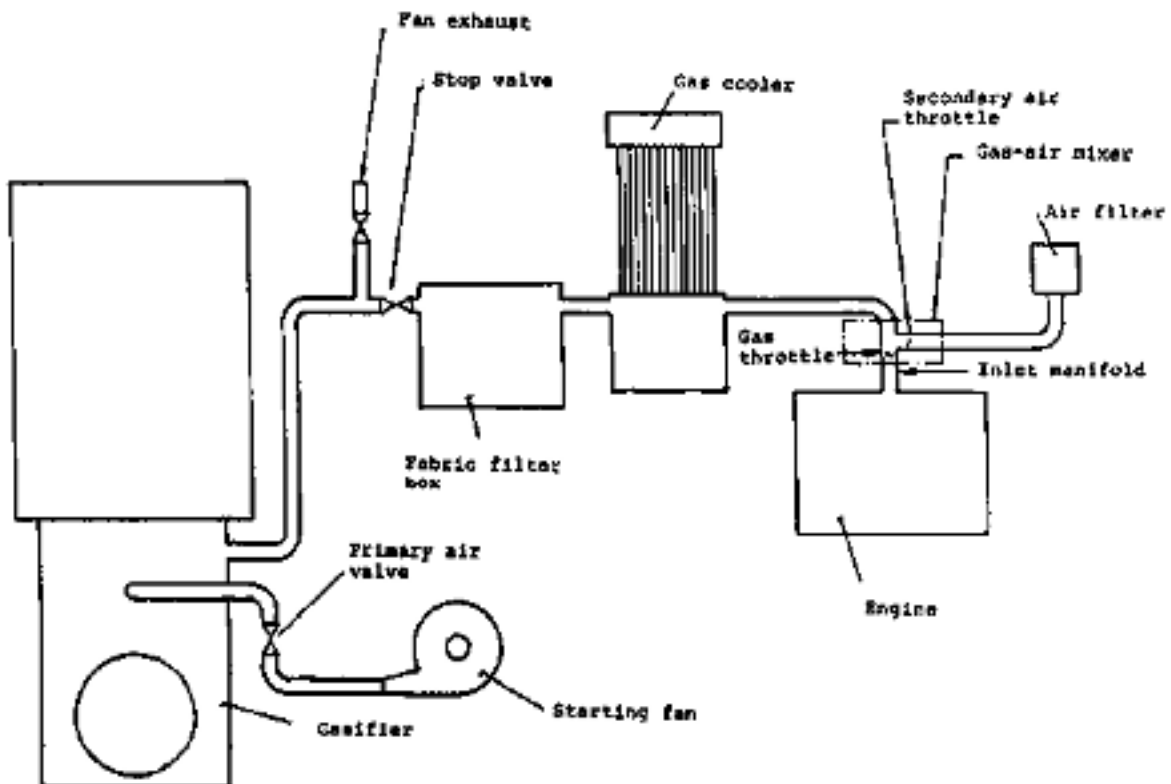

Figure 3.9 Picture of a Massey Ferguson 1100 farm tractor converted to wood gas operation

Type of truck	Engine data				Producer gas fuel	Fuel consumption		Operating record km
	Ignition system 1/	Cylinder volume (dm ³)	Compression ratio	Power output kW 2/ Original After conversion		Solid kg/10 km	Liquid l/10 km	
Scania Vabis 6/ L5150	C.I.	6.2		57 52	Wood blocks	6.1-7.7	0.42-0.48	
Volvo 6/ L389	C.I.	6.7		62 51	Wood blocks Wood chips	4.9-8.9	0.44-0.63	117 000
Scania Vabis 6/ L75	C.I.	10.3		90 72	Wood chips	6.9-19	0.71-1.34	272 000
Scania 6/ L8050	C.I. C.I.	7.8	15.9:1 6/	70 50	Wood chips	7.2-7.8	0.57-0.63	4/
Scania 6/ L85 110 (1970)	C.I.	11.0		116 68	Wood chips	9.5	0.73	163 700
Volvo 6/ 888	S.I.	7.5		3/ 3/	Wood chips	3/	3/	3/
Ford 3/ Dc710 (1980)	S.I.	7.5	10.1 6/	3/ 3/	Wood blocks	1/	-	1/
Volkswagen pickup VK 9238 (1982)	S.I.	2.0	10.1 6/	51 29 (e)	Charcoal	1.5-2.5	-	2 800 5/
Nanda pickup 3/ (1983)	S.I.	2.0	8.2:1	58 30 (e)	Wood blocks	3/	-	1 500 4/

1/ C.I. Compression ignition. S.I. Spark ignition.

2/ Measured data if not indicated by (e) when data are estimated.

3/ Data not available.

4/ Still in operation.

5/ Reduced from original value.

6/ Increased from original value.

7/ The tests in Sri Lanka with this truck have not yet been started.

8/ Converted as part of the programme conducted by the National Swedish Testing Institute for Agricultural Machinery.

9/ Converted by the Nijer Institute for field tests in developing countries.

10/ Converted by Energetiska Energisystemteknik AB for field tests of commercially available gasifier systems.

Table 3.12 Specification of Massey Ferguson tractor converted to producer gas

<u>Tractor</u>	
Model and number	Massey Ferguson 110 nr 915 12763
Total weight in producer gas version	5090 kg
<u>Engine</u>	
Type and number	Perkins diesel engine, direct injection nr VA 5143
Cylinder volume	5.8 dm ³
No. of cylinders	6
Compression ratio	16:1
Injection pump:	Distributor type with a centrifugal regulator CAV type DPA 326 2948
Injectors	CAV type BDLL 150 S 6472
<u>Gasifier system</u>	
Gasifier	Type F3 5/80-150
Fuel bunker volume	0.2 m ³
Throat diameter	120 mm
Nozzle diameter	12 mm
Gas filter	Industrifilter AB
Filter area	4.9 m ² 1)
Gas cooler	Type D
Cooler area	5.8 m ²
Total weight	450 kg

1/ Originally 2.5 m². This required cleaning every 20 hours which was not considered acceptable.

The gasifier and the gas filter are mounted on consoles bolted to the body on the left side of the tractor. The free height of the gasifier above ground is 500 mm. The gas cooler is mounted on consoles in front of the engine cooler.

Only minor changes to the original tractor were necessary. The headlights were moved to the top of the roof, since the left light would otherwise have been obstructed by the gasifier. The air filter has been turned so that the insert can be removed from the right hand side of the tractor since the gas filter box on the left side of the tractor would prevent servicing of the air filter in its original position. A new opening has been made in the engine hood for the air inlet pipe to the air filter. The loose weights and their brackets on the front of the tractor have been removed, to make space for the gas cooler. The engine has been fitted with an extra speed governor, acting on the gas throttle in the gas/air mixer. The governor is driven by a V-belt from an extra pulley mounted on the fan shaft. The diesel injection system required the most substantial changes. The injection pump was of the distributor type with a centrifugal regulator. The original injection system gave injection at reduced engine speeds exceeding the amounts which are required for dual fuelling. The result of this is that the injection will be unnecessarily large at low speeds.

A constant injection amount was obtained by mounting an adjustment device for the fuel pressure normally used on pumps with an hydraulic speed governor. Fig. 3.10 shows the injection characteristics of the original and modified systems.

Overheating of the pump was avoided by leading the excess flow to the fuel tank as described in section 3.1.4. A radiation shield was also mounted to protect the pump and the fuel filter from being heated by the hot gasifier which is mounted on the same side as the pump. ^{1/} The injection pump was fitted with an adjustable stop for the engine stop-lever, close to the zero injection position. With the lever at this stop the injection flow is less than required for idling, which means that the engine can be stopped just by closing the gas throttle even though the diesel flow cannot be shut off completely. The stop lever can also be adjusted by the driver to a full diesel position, enabling starting and driving on diesel oil, if required.

^{1/} These changes were not done originally. After 25 hours of operation the pump seized, and this was attributed to insufficient cooling and lubrication. After the changes described here, the pump operated satisfactorily

Figure 3.10 Injection characteristics of the original and modified fuel injection system for the Massey Ferguson 1100 farm tractor

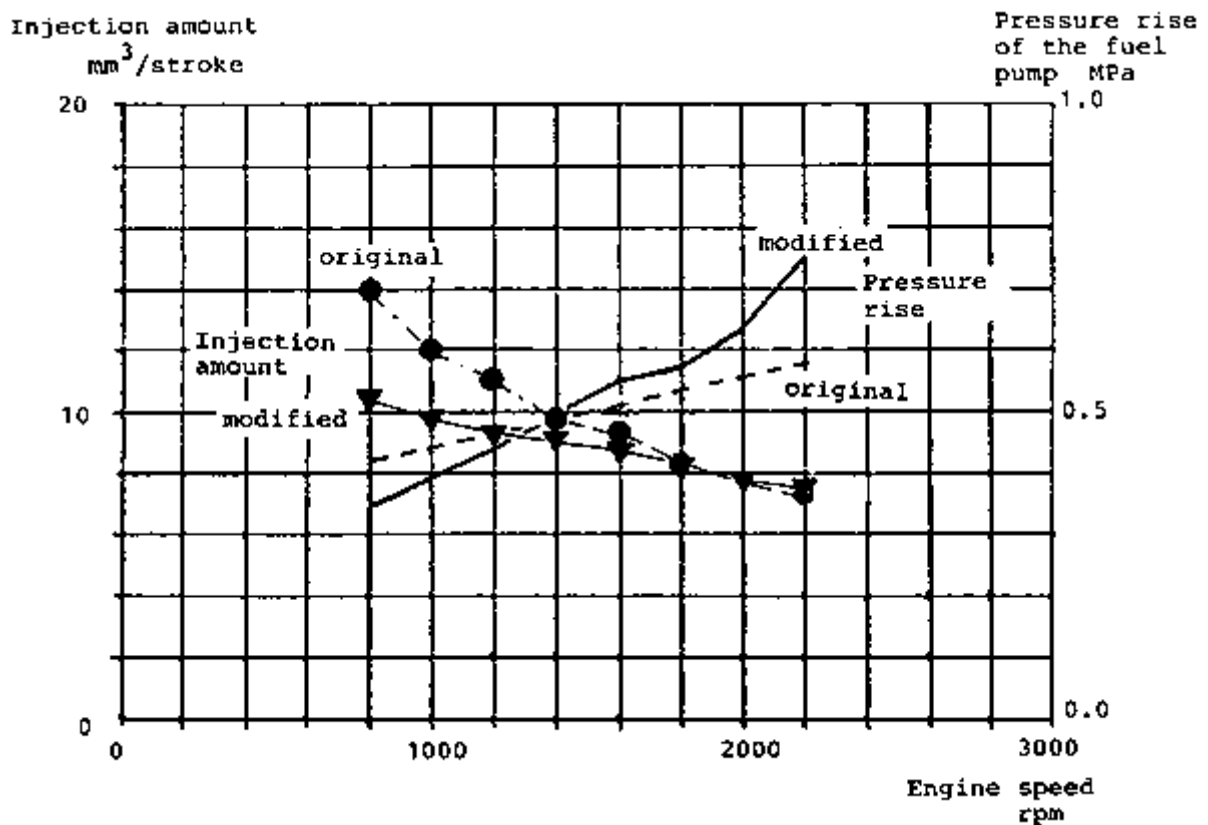

The mounting of the injectors was also modified, since it turned out after a few hours of operation with the original design that the injectors were running hot and suffering from coke deposits in the nozzle holes. This was caused by a combination of the low injection flow in dual fuel mode, and the way the injectors were mounted in the cylinder head. The engine is equipped with a cylinder head covering all six cylinders. The holes for the injectors are made in the cast material. This leads to poor cooling of the injectors, partly because of the low thermal conductivity of the cast iron, partly because the wall thickness is large.

To improve the cooling of the injector a copper sleeve was mounted on the injector and by opening a connection between the space where the injectors are placed and the cooling water channels in the cylinder head. This change was fairly simple to make. After this

modification, it was necessary to drain the cooling water from the engine before removal of the injectors.

The total height of the gasifier above ground is 222 cm. The eye level of the driver is 225 - 240 cm, depending on how the seat is adjusted. The field of vision in the forward left direction is partly obstructed by the gasifier and the filter box. To the right and backwards, the field of vision is not affected.

b) Laboratory performance tests

Laboratory tests were carried out to establish the performance of the gasifier system and the converted engine.

A summary of the test results is given in Table 3.13 and Fig. 3.11. The maximum power in dual fuel mode was found to be 51 kW at about 2170 rpm (injection timing 30° before TDC). This is 79% of the maximum power for straight diesel operation at recommended injection timing (22° before TDC) and 76% of the diesel power at the same injection timing as for dual fuelling. As can be seen in Table 3.13, the diesel oil substitution was found to be 80-85% and the efficiency of the gasifier system about 70%. Solid residue in the ash pit was found to be up to 3.5% of the fuel consumption. This would account for a loss of about 5% at full power.

Tests were also made with injectors other than the original four hole type. Pintle type injectors in the original cylinder head showed no tendency for coking - the injectors are self cleaning - but the maximum power in dual fuel operation was 19 percent lower than for the four hole type. Straight diesel operation with this injector was not considered possible, since very smoky exhaust gases were already obtained at low powers. Two-hole injectors gave the same power output in dual fuel mode as the four-hole injectors for engine speeds up to 1900 rpm and slightly less above. For straight diesel operation, the power output was generally lower than for four-hole injectors over the whole speed range.

Figure 3.11 Total efficiency at part loads for a F-5/80-150 gasifier system mounted on a Massey Ferguson tractor.

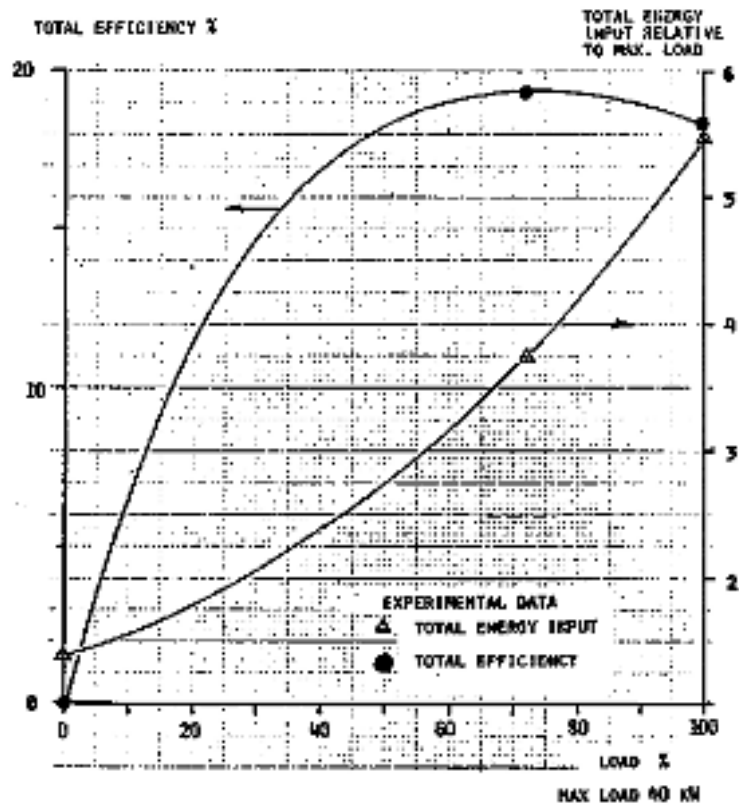

Table 3.13 Results of laboratory tests with F-5/80-150 gasifier system mounted on a Massey-Ferguson 110 tractor.

<u>Fuel</u>	Wood chips, moisture content 8%, bulk density 152 kg/m ³		
<u>Rating</u>	Max.	Part	Idling
Engine speed (rpm)	1855	1440	1015
Output power (kW)	40	29	-
<u>Fuel consumption</u>			
Wood chips (kg/h)	41	27	8.5
Diesel oil (kg/h)	2.2	1.9	1.2
<u>Energy balance</u>			
Gas heating value MJ/Nm ³	5.60	5.56	5.54
Diesel oil fraction of fuel energy (%)	18.9	15.0	26.2
Total efficiency	18.0	5.3	0
Gasifier cold gas efficiency (%)	71.1	66.5	73.1
Energy losses total (kW)	181.5	143.3	54.8
Energy losses, gasifier (kW)	56.3	43.0	10.1
<u>Hearth load</u>			
B _g (Nm ³ /cm ² , h)	0.79	0.49	0.17
<u>Tar content</u>			
g/Nm ³	0.13	0.04	0.17

c) Experiences from practical operation

The tractor was used in practical operation for more than 2500 hours during a six year period at two large farms in southern Sweden. The tractor was mainly operated by agricultural students, since the regular tractor drivers were not interested in using it. The main reason given for this is that the daily service is time consuming, dirty and heavy. Preparation for operation requires 30 - 45 minutes. Large amounts of wood chips must be loaded on the roof for the operation during a full work shift.

Education of a new driver has required one to two weeks. Each student has been responsible for the tractor during one six month period.

The tractor has been used for the following types of work:

- Soil treatment with	clod crusher	4 m wide
	peg-harrow	5 m wide
	disc-harrow	2 m wide
	land-packer	6 - 10 m wide

Transport of beets, grain and fertilizers.

The gasifier system has worked satisfactorily. Average times between cleanings of different parts of the system and other service measures as well as failures are discussed in section 3.2.4. The injectors, which were believed to be critical for reliability, have not caused any trouble. One serious engine failure was experienced. This was probably caused by water sucked by the gas from an overfull condensate vessel in the gas cooler.

3.2.3 Conversion and operation of a Scania truck

a) General description of the converted truck

The experiences from conversion of this truck have been reported (in Swedish) by Axelsson (2). The gasifier system, which originally was the prototype design type F5, was later replaced by the mass production prototype design F500. This change was made in 1979 after approximately 45000 km. Table 3.14 gives the main data for the converted vehicle. The gasifier system is shown in Fig. 3.12, and a picture of the converted truck in Fig. 3.13.

The entire gasifier system including the gas cooler is mounted on a frame which is bolted to the chassis behind the driver's cabin. To make space for the gasifier installation, the platform was shortened. The distance between the cabin and the platform is now 108 cm. This reduced the platform area to about 80 percent of the original.

Figure 3.12 Schematic of gasifier system used for a Scania L8050 truck

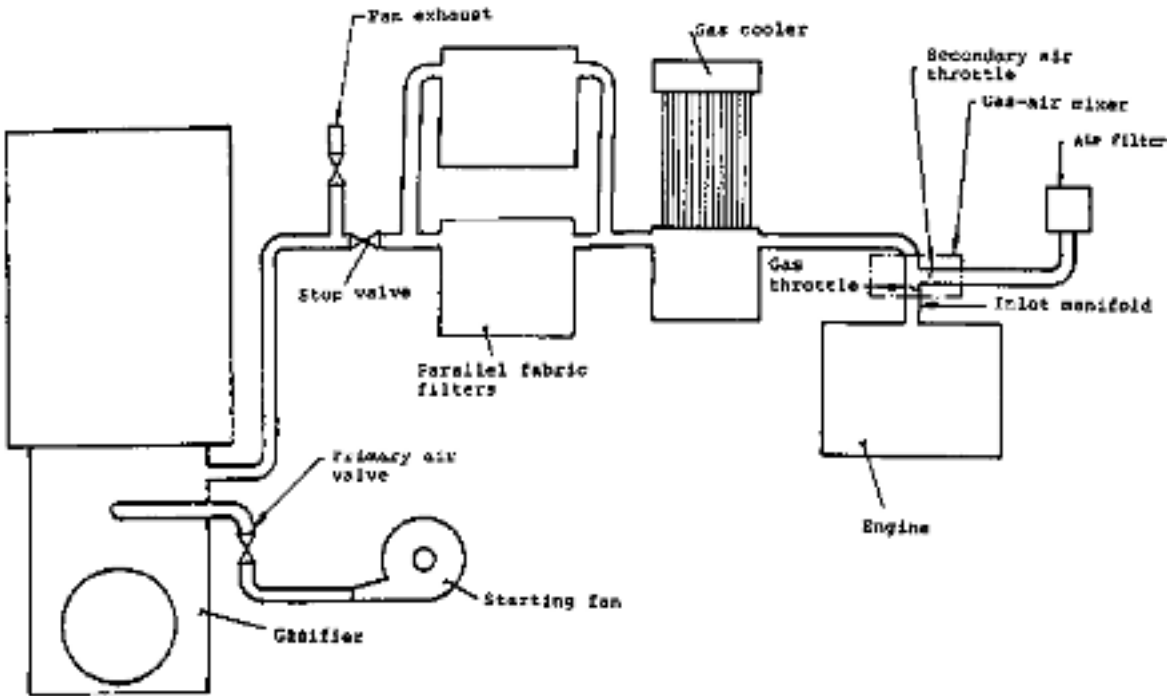

Figure 3.13 Picture of a Scania L8050 truck converted to wood gas operation



Table 3.14 Specification of Scania truck converted to producer gas

<u>Truck</u>	
Model and number	Scania L8050 nr 365472
Total weight in producer gas version	8350 kg
Load capacity	7600 kg
<u>Engine</u>	
Type and number	Scania diesel engine nr 735 145
Cylinder volume	7.8 dm ³
Number of cylinders	6
Compression ratio	15.9:1
Injection pump	In-line type with vacuum regulator type CAV NR6H80/338 GLPE 34
Injectors	CAV type BDLL 150S 6403
<u>Gasifier system</u>	
Gasifier type	F-S/80-150 <u>2/</u>
Fuel bunker volume	0.031 m ³
Throat diameter	150 mm <u>1/</u>
Nozzle diameter	12 mm <u>1/</u>
Gas filter	Industrifilter AB
	Two standard boxes in parallel
	Filter area: 6 m ²
Gas cooler	Type D 2
	Cooler area 5,8 m ²
Total weight	456 kg

1/ Tests have been done also with throat 165 mm and nozzles 14,5 mm. This gave 1% improved max. power.

2/ Later replaced by type F500.

The injection pump is of the in-line type, and equipped with a vacuum regulator. The delivery valves have idling holes. No modifications to the injection pump were made. The damper for the regulator was adjusted to suppress tendencies for oscillations of the control rod.

The injection pump is set for dual fuel operation by moving the stop lever from the full feeding position to an adjustable stop close to the zero feed position. This gives a fuel flow below that required for idling.

Therefore it is possible to shut off the engine by moving the lever to this position when the engine is operated on straight diesel oil or by closing the gas throttle when the engine is operated with dual fuel. The lever can be operated from the driver's cabin using the ordinary stop control. The injectors are mounted in steel sockets in the cylinder head. The steel sockets are directly surrounded by cooling water. No modifications to avoid overheating of the injectors were made since it was assumed that this would not be necessary.

A gas/air mixer, Fig. 3.14, was connected to the inlet manifold of the engine. The gas throttle is manoeuvred by the gas pedal, the secondary air throttle by a manual control in the

driver's cabin. The compartment between the two throttles in the secondary air line is connected to the vacuum chamber of the injection pump regulator. This makes it possible to use the regulator to limit the runaway speed of the engine. The air filter was moved to make space for the gas/air mixer. The crank case ventilation was changed to a closed system in order to avoid leakage of poisonous gas. The ventilation pipe, which originally opened to the atmosphere below the engine, is now connected to the hose between the air cleaner and the gas/air mixing valve.

The truck was tested using different compression ratios and injection timings in order to find the most suitable combination. The results of these tests are summarized in Table 3.15.

It was found that the best performance in dual fuel operation was obtained with a compression ratio reduced from 1:16.5 to 1:15.9 and injection at 35 before TDC. The reduced compression ratio was achieved by using one of the copper sheets from a cylinder head gasket as an extra spacer between the cylinder head and the engine block.

b) Laboratory performance tests

Laboratory performance tests were carried out to establish the performance with different compression ratios, injection timings, throat and air nozzle diameters and designs of the gas/air mixing valve.

Figure 3.14 Gas air mixers tested for the Scania L8050 truck - a. Gas-air mixer of Scania Vabis design

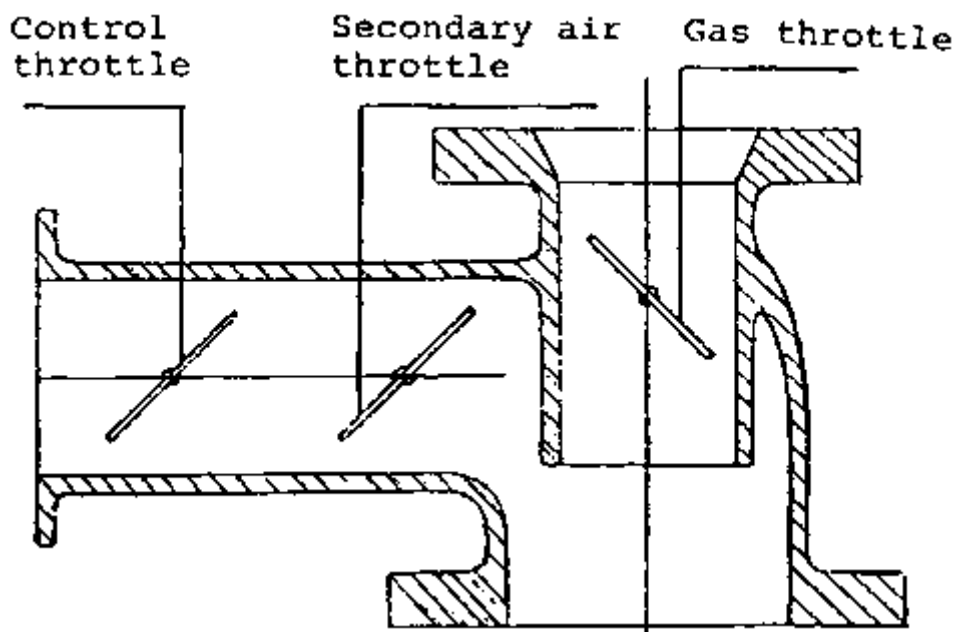

Figure 3.14 Gas air mixers tested for the Scania L8050 truck - b. Gas-air mixer designed by the National Testing Institute for Agricultural Machinery

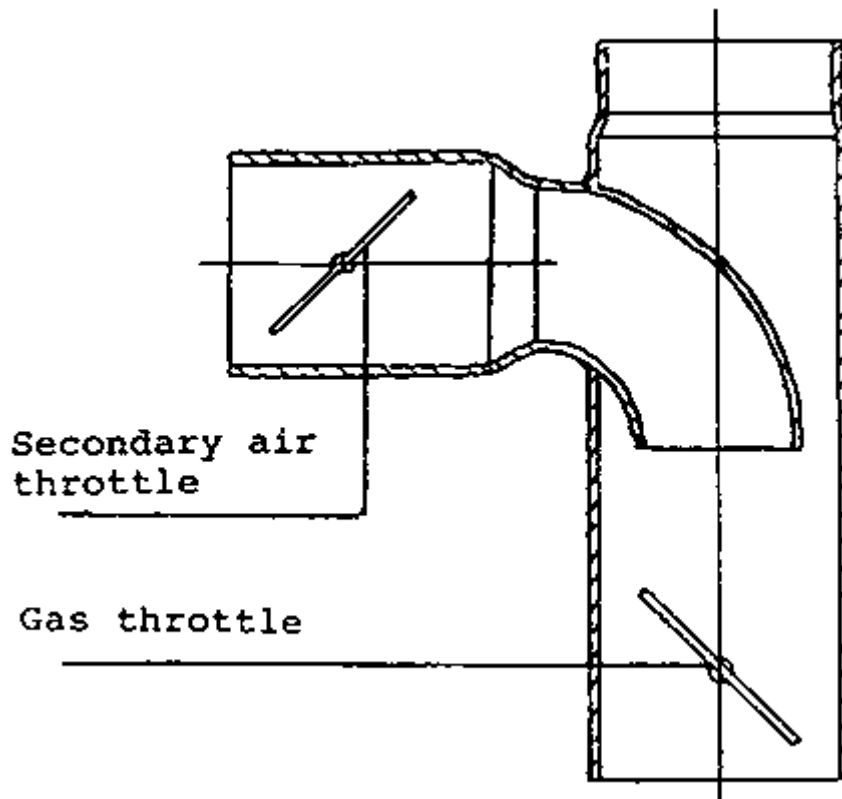

Table 3.15 Experiences from tests with different compression ratios and injection timing for dual fuel operation of a Scania D8 engine

Compression ratio	Measures taken to change compression ratio	Injection timing ° before TDC	Experiences
16.5:1	Original engine	30	Knocking
		25	No knocking, reduced power
13.9:1	Double cylinder-head gaskets	25 - 39	No knocking, but starting difficulties and reduced power
15.9:1	Single gasket together with one coppersheet from another gasket	36	Knocking at low engine speeds (of limited practical importance if the correct gear is used).
		32	No knocking even at low speeds but some power loss at high speeds.

The conclusions from these tests have been summarized in the preceding section.

The maximum power for straight diesel operation was found to be 70.5 kW (at 2090 rpm) with the reduced compression ratio. After mounting the gas/air mixer and adjusting it, and adjustment of the injection timing to 35° before TDC, the power was reduced to 60.2 kW (at 1720 rpm). The maximum power output for dual fuel operation was found to be 49.8 kW (at 2230 rpm), i.e. 71 percent of the power for straight diesel operation at the reduced compression ratio.

The diesel oil injection was found to be about 15 percent of that for straight diesel operation.

c) Experiences from practical operation

The truck has been operated since March 1969, and has covered more than 91500 km in dual fuel operation, and 28000 km using straight diesel oil. It is still operational. The truck has been used for various types of transport, to teach drivers, for tests with different types of fuel and for demonstration.

Table 3.16 shows the fuel consumption as determined in practical operation for different loads. The diesel oil substitution is about 80 percent, compared to straight diesel operation of the truck in its converted version. The consumption of wood chips for substitution of 1 kg of diesel oil is about 3.6 kg, indicating a practical efficiency of the gasifier system of about 71 percent.

Training for dual fuel operation of a driver with earlier experience of driving a diesel truck requires only about five hours, three of them theoretical preparation, and about two of practical training. Such quickly trained drivers have used the truck on several occasions for round trips of several thousand kilometers without major problems. The drivers have, however, remarked that city driving - in particular in Stockholm - with dual fuel is much more inconvenient than highway driving. In the city, more planning was necessary to refuel in a suitable place. The large smoke clouds exhausted during fanning were considered a problem. Poor acceleration after stops at traffic lights was also found inconvenient.

During the practical testing, records were kept on fuel consumption, service and maintenance intervals, and equipment failures. A summary of these records is given in section 3.2.4.

Table 3.16 Fuel consumption observed in practical dual fuel or straight diesel operation of a Scania L8050 truck

Load	Straight diesel operation	Dual fuel operation <u>1/</u>			
	Diesel oil kg/10 km	Diesel oil kg/10 km	Wood chips <u>2/</u> kg/10 km	Diesel oil substitution	Gasifier system efficiency
Empty	2.44	0.50	7.2	80	69
5000 kg	2.61	0.50	7.6	81	71
8000 kg	2.87	0.55	7.8	81	76

1/ Average speed about 60 km/h.

2/ Wood chips 10 x 10 - 40 x 40 mm, moisture content 8 - 10%.

3.2.4 Experiences related to service, maintenance and equipment failures

For an economic assessment of straight wood gas or dual fuel operation of farm tractors and other vehicles, data for extra service time, as well as costs and time required for maintenance and repair are of great importance.

Records on service and maintenance intervals as well as equipment failures have been kept for the vehicles tested by the National Swedish Testing Institute for Agricultural Machinery,

see Tables 3.17 and 3.18. There are variations between different vehicles and, rather than presenting here the experiences for the two vehicles reviewed in detail, it has been preferred to present integrated experiences based on the operation of several of the vehicles. Table 3.18 shows approximate service intervals and the approximate time required for the service jobs.

Assuming that the vehicle is used eight hours per day, the service time required for the gasifier system can be estimated as 15 - 25 minutes per operating hour, including refuelling stops.

The approximate repair intervals for different critical components are given in Table 3.18, which is based on experiences from practical operation of several vehicles. These experiences are not necessarily representative of what would be found if the technology were in widespread regular use. The present experiences may be biased in a negative direction because the systems tested were to a large extent first or second generation prototypes - they were also manufactured with the cheapest materials which could reasonably be used. Commercial products in regular use could be expected to show longer lifetimes if they are maintained and operated like the prototypes.

The experiences may, however, also be biased in a positive direction because the operators of the test vehicles have been more keen and interested in the functioning of the system than the average operator might be if the technology were widely used. Most of the service and maintenance tasks are dirty. This may lead to neglect by some operators. There are also some difficulties associated with the assessment of the failure rates which could be expected for other operating situations. Some of the failures, like chafing of filter bags, and cracking of throat plates are clearly related to the number of operating hours. Others such as corrosion damage could be more dependent on the actual age of the component.

The repair costs for the prototype systems are probably not at all representative of the costs which would be experienced in practical operation. Mass produced spare parts would be much cheaper than the spare parts made specially for the prototypes.

Table 3.17 Service and maintenance intervals for vehicle gasifier systems in practical operation

	Interval	Time required
Daily preparation for operation	Every day of operation	30 - 45 min.
Fuel charging	Every 40 - 50 min.	Less than 5 min.
Draining of condensate tank on gas cooler	Every 2 - 3 h	Less than 5 min. <u>1/</u>
Removal of ashes from gasifier ash pit	Every 8 - 15 h	15 - 30 min. <u>2/</u>
Draining of condensate tank on gasifier	Every 8 - 10 h	Less than 5 min. <u>2/</u>
Cleaning of hose between primary air intake and starting fan	Every 55 h About 1 h	
Cleaning of fabric filter	Every 25 - 100 h <u>3/</u>	30 - 60 min.
Cleaning of condensate jacket	Every 75 - 135 h	1 - 2 h
Replacement of various gaskets	Every 500 h	About 1 h
Cleaning of gas cooler and inlet manifold	Every 500 h <u>4/</u>	1 - 2 h

1/ Done during refuelling stop

2/ Can normally be done as part of daily preparation. Time given for that includes these tasks.

3/ The cleaning interval depends on the pressure loss accepted and the size of the filter surface relative to the gasflow.

4/ Cleaning required after gas filter failures. Frequency estimate based on observed failure rates for filter bags.

Table 3.18 Lifetimes of some critical components between repair or replacement according to practical operation experiences

Component or part of the system	Operating time between failures (h)	Type of failure and repair	Comment
<u>Gasifier</u>			
Fuel lid and upper part of gasifier	Above 4000		Age about six years or more
Lower part including condensate jacket and ash pit.	2000 - 4000	Corrosion - Patch or replace damaged part.	The test gasifiers have used mild steel for these parts. Use of corrosion resistant alloy will increase lifetime.
Fire box	600 - 1000	Cracks, deformation - weld or replace.	
Throat ring	About 700	Cracks, deformation - weld or replace.	
Grate and grate mechanism	400 - 700	Cracks, deformation - weld or replace.	
<u>Fabric filter</u>			
Filter bags	500 - 1000	Chafing, burn-holes - replace	
Filter box	Above 4000		
<u>Gas cooler</u>			
Cooling elements and condensate tank	1500 - 2000 4000	Corrosion - Patch General corrosion - replace	
<u>Engine</u>	Above 4000		Inspection of the engine of the Scania truck LBS 110 after 190000 km (about 4000 h) showed slightly more cylinder wear than for straight diesel operation.

It does not seem unreasonable to assume a lifetime of about six years for the gasifier system in general, and a repair cost of five per cent of the capital investment per 1,000 hours of operation. The repair cost is estimated on the assumption that the filter bags must be replaced every 500 - 1,000 hours, and that repairs to the parts of the system exposed to high temperature or corrosive condensates are necessary with about the same frequency.

3.3 Producer gas vehicles recently operated in other countries

Recent operating experience from conversion and operation of vehicles on producer gas is not restricted to Sweden. The format of this chapter does not allow a review and evaluation of the experiences of other countries, but it is of interest at least to identify possible additional sources of information regarding this application of gasifiers.

In the countries listed below, producer gas vehicles are known to have been operated in the last decade. The list is not claimed to be complete, but it still shows that there is a certain

interest in producer gas vehicles outside Sweden, even though only two countries, the Philippines and Brazil, appear to have more than a few prototype units in operation.

In (30) brief reports on producer gas vehicles in the following countries are given.

Australia	A small pick-up truck using wood chips as fuel.
Belgium	Two trucks, one using charcoal, the other wood or biomass residues as fuel.
China	A logging tractor using wood as fuel.
Finland	A farm tractor using wood as fuel.
France	Six large trucks using wood as fuel, see also (45).
Germany	At least two farm tractors have been converted to wood gas by two different manufacturers of gasifiers.
Laos	A jeep using a charcoal gasifier has been operated since 1981.
South Africa	The government is reported to be making a major drive for use of wood fuelled gasifiers for small engines. There have been at least two operating vehicles, probably using charcoal as fuel, see Gore (15).
USA	A least three wood powered cars have been driven across the country. There is also a wood powered motorcycle and a wood powered farm tractor.

Reports on operation of single vehicles have also been received from Kenya, Sri Lanka (see 24), the Seychelles and Tanzania. These vehicles, except the one in the Seychelles, use charcoal as fuel. The tests reported by Kulasinghe (24) are particularly interesting, since the equipment was designed and manufactured locally.

In Brazil and the Philippines finally, commercial production of gasifier systems for vehicles has started. Charcoal is the main fuel used. The number of vehicles in operation is reported in (12) to be about 300 in Brazil and 200 in the Philippines. More details of the programme in Brazil have been reported by Brandini (8).

3.4 Economic evaluation of operation of vehicles on wood gas

3.4.1 The case for wood gasifiers

Installation of a gasifier system on a vehicle involves a certain investment, leads to somewhat impaired performance, and increased time required for service, maintenance and repair. All this can be translated into increased costs for the vehicle. Wood gas operation is only economically feasible if these costs are outweighed by the savings on fuel costs.

It can be inferred from this that wood gas operation will be most competitive in situations where the annual utilization of the vehicle is high, the labour wages low and the price difference between petroleum fuels and wood is large.

An attempt will be made below to identify the ranges for these parameters where wood gas operation may be a competitive alternative.

3.4.2 Method used for the economic evaluation

The purpose of the economic evaluation presented here is to illustrate under which circumstances wood gas operation of a vehicle may compete with straight diesel operation.

This will be done by a comparison between the marginal costs for the gasifier system and the savings on fuel costs for two applications, a farm tractor and a truck, of the same size as those described in section 3.2.

Three cost levels for the gasifier system will be analyzed, a high level representative of conversion of single vehicles in Sweden and two lower levels assumed to represent conversion of single vehicles in countries with much lower labour costs.

A range of labour costs and a range of fuel costs believed to represent the present situation in Sweden as well as in the Third World will be analyzed. Capital costs will be calculated by the annuity method assuming a fixed real interest rate $\frac{1}{i}$. All costs will be evaluated in US dollars at a mid-1984 rate.

$\frac{1}{i}$ The real interest rate is equal to the actual interest rate minus the inflation rate.

3.4.3 Economic baseline assumptions

The economic evaluation will be made assuming a real interest rate of eight percent with labour wages in the range 0.5 - 16 US\$/hour with a price of diesel oil of 8 - 16 US\$/GJ and wood fuel of 0.1 - 3.5 US\$/GJ. It should be mentioned that in Sweden the labour wages are about 16 US\$/h. Diesel oil is sold at about 0.3 US\$/l, i.e. 8.5 US\$/GJ and wood chips as a commercial fuel at 3.4 US\$/GJ.

In Chapter 4, the cost of preparation of gasifier fuel is estimated to be $0.11 h + 0.04 \text{ US\$/GJ}$, giving a cost of 0.1 - 1.8 US\$/GJ for the range of wages considered here. Diesel fuel in remote locations was estimated to cost 12.6 US\$/GJ.

In Chapter 5, finally, the cost of coconut shell as fuel is estimated to 0.8 US\$/GJ.

3.4.4 Marginal costs for the wood gasifier system

a) The capital cost

The marginal capital cost can be calculated by the annuity method if the capital investment and the economic lifetime of the gasifier system can be established.

The capital investment can be estimated from a recently converted Ford D-truck used for tests in Sri Lanka, which has been fitted with a gasifier system similar in size to the standard F-5/80-150 gasifier.

Table 3.19 shows how the different items of expenditure add up to the total conversion cost of about US\$ 11000. This obviously is the conversion cost for a single vehicle converted in Sweden at a high labour cost (14.8 US\$/h). It is quite clear that the labour cost is important since the manufacturing labour and fitting costs account for over 70 percent of the conversion cost. To illustrate the impact of a lower labour cost, Table 3.19 also shows the estimated conversion cost in a developing country with labour costs of 2 and 0.5 US\$/h. In these estimates it is assumed that the time required is twice as high as a result of less well equipped workshop facilities and that the material costs are 10 percent higher. The conversion cost under these assumed conditions would be about US\$ 5300 and US\$ 3600 respectively.

With an assumed economic lifetime of six years and a real interest rate of eight percent, the annual capital cost for the gasifier system will be 21.6 percent of the capital investment.

b) Service and maintenance costs

Based on the experiences presented in section 3.2.4, the extra labour to keep the gasifier plant in operation can be estimated as 0.3 in/operating hour. The resulting cost will obviously depend on the labour rate, see Tables 3.20 and 3.21. The maintenance cost has been assumed to be five percent of the capital investment for each 1000 operating hours. This leads to an estimated maintenance cost for operation in Sweden of 0.55 US\$/operating hour, and 0.18 US\$/operating hour in a country with a low labour cost.

For the economic evaluation of the wood gas truck, it will be necessary to consider the reduced load capacity and the longer distance travelled for a given load. The service and maintenance costs of the truck and engine will be assumed to depend on the annual driving distance according to Swedish experiences. For 60000 km/year it will then be 0.66 US\$/km, for 30000 km/year 0.80 US\$/km and for 1500 km/year 1,40 US\$/km.

Table 3.19 Cost of converting a vehicle to wood gas operation

Cost item	Actual cost-for conversion of a truck in Sweden	Conversion in countries with lower labour costs		Comments
		Estimated conversion cost, wages 2 US\$/h	Estimated conversion cost, wages 0.5 US\$/h	
	US\$	US\$	US\$	
Engine	753 <u>1/</u>	753	753	This is the cost of replacing the diesel engine by a renovated used gasoline engine. It will be assumed representative of the cost of the necessary adjustments to a diesel engine for dual fuel operation.
Gasifier and gas cooler	652	391	313	Material cost increased by 10%, labour time increased by a factor of 2.
Gas filters	1600	960	768	"
Starting fan	244	268	268	Cost increased by 10%
Fittings, valves, gaskets, auxiliaries, controls	987	1086	1086	"
Fitting	6782	1808	452	Labour time increased by a factor of 2.
Total	11018	5266 <u>2/</u>	3640 <u>2/</u>	

1/ At labour wages of 15 US\$/h.

2/ These estimates do not appear unreasonable in comparison with costs reported for somewhat simpler systems manufactured in Brazil (750-2000 US\$) and Sri Lanka (1000 US\$).

c) Fuel costs

Fuel costs will be calculated assuming dual fuel operation and a fuel consumption for the tractor according to Table 3.13 and for the truck according to Table 3.16.

3.4.5 Economy of a producer gas tractor

The annual difference in cost between a diesel tractor and a wood gas tractor will be evaluated for three economic situations, namely:

- European conditions (Sweden)	
Wages	16 US\$/h
Wood fuel	3.5 US\$/GJ
Diesel fuel	8.5 US\$/GJ
- Intermediate conditions	
Wages	2 US\$/h
Wood fuel	2 US\$/GJ
Diesel fuel	8,5 US\$/GJ
- Favourable conditions for producer gas	
Wages	0,5 US\$/h
Wood fuel	0,5 US\$/GJ
Diesel fuel	16 US\$/GJ

The annual utilization will be assumed at 500, 1000 and 2000 hours. This range is believed to cover what is encountered in practice. To simplify the comparison, it will be assumed that the power loss of 20 percent can be accounted for by adding an investment to the producer gas alternative equivalent to the difference in cost for new tractors with that power difference. The cost difference can be estimated to be about US\$ 2500 and it will be assumed that it must be depreciated on 10000 operating hours. The comparison is made in Table 3.20 where the indifference costs for wood fuel and diesel fuel are also shown for each case.

It is quite understandable that wood gasifier tractors are not in regular use in Sweden. The operation implies a loss even if the wood fuel is free of charge. It is not until the price of diesel fuel increases by 100 to 200 percent that a wood gas tractor would be economic.

[Table 3.20 Economic Comparison between a Wood Gas Tractor and a Diesel Tractor \(1984 US\\$\)](#)

[Table 3.21 Economic comparison between a wood gas truck and a diesel truck](#)

The situation is quite different if the wages and the cost of fuel wood are lower. For the intermediate case analyzed the producer gas tractor will be economic if the annual operating hours exceed about 700. At the very lowest wages and wood fuel cost, and the high cost for diesel fuel, the producer gas tractor appears very attractive. The payback time for the gasifier system is of the order of 13 to 36 months under the conditions analyzed for this situation. It is an interesting observation that use of expensive systems built in Europe would not entirely eliminate the-economic possibilities for gasifiers in the Third World. The producer gas tractor would still be economic in the case of very low wages and wood costs and with a high price for diesel fuel. In the intermediate case it would still be economic for long annual operating times. It is also true that even a very cheap gasifier system would not be economic in Europe. Even if the gasifier did not cost anything, the additional labour costs exceed the savings on fuel and this eliminates any possibility of economic operation with producer gas, except perhaps in cases where the tax system works in such a way that a person's own labour effectively costs much less than that of hired hands. 1/

1/ The situation could be applicable under some circumstances in Sweden.

3.4.6 Economy of a producer gas truck

The difference in annual cost between a diesel truck and a wood gas truck will be evaluated for the same economic situations as considered for the tractor. The initial cost of the truck is assumed to be US\$ 28000, with ten percent added for freight costs to a third world country.

The difference in cost is shown in Table 3.21 for three utilization levels, i.e. 60000, 120000 and 240000 tons and kilometers per year.

The average velocity is assumed to be ten percent less for producer gas operation, mainly because of stops for fuel charging. In European conditions the average velocity is assumed to be 60 km/h for the diesel vehicle. In the other cases, where road conditions are less favourable, the average velocity is assumed to be 25 km/h.

As can be expected, the results of the comparison are qualitatively similar to those presented for a farm tractor. Wood gas operation in Sweden will not be economic until the diesel price has increased considerably - by more than 200 percent.

Under intermediate conditions where wages and the price of fuel wood are lower, wood gas operation does not appear economic either. This is a different conclusion from the tractor case, and can be explained by the differences in use pattern. If it had not been necessary to drive the wood gas vehicle a longer distance to carry the same load, the wood gas truck would have been marginally economic for the case of 240000 ton km/year. The increase in diesel fuel price required for wood gas to be economic is between 100 percent and 25 percent. For long distances driven annually, it may be economic at the present oil price if the wood is extremely cheap.

For the extreme case of low wages, low fuel wood price and high price of diesel fuel, the wood gas truck appears extremely profitable with a pay-back time of two years or less for the gasification equipment.

3.5 Feasibility of using the vehicle gasifier technology for stationary applications

Vehicle gasifier systems must be of compact and lightweight design. To achieve this, some sacrifices of efficiency may be necessary. More frequent servicing may also be required. Vehicle gasifier systems, for instance, are almost exclusively fuelled manually. The compact designs of ash pits and filters make fairly frequent cleaning necessary.

The lightweight design will imply minimum use of material which as a consequence leads to a shorter lifetime for parts exposed to corrosion. This may appear to be a serious shortcoming for use in stationary applications, but it must also be understood that lightweight and compact designs bring some advantages, which for some stationary applications will outweigh their negative consequences. Lightweight and compact designs can be built more cheaply and with less well equipped workshop facilities. Transport to the site will be simpler and cheaper. Site assembly work can be virtually eliminated, since the power plant can be built and transported as a unit. All this will result in lower capital costs.

Finally, the choice of technology will depend on an economic evaluation. It is then quite possible that vehicle type systems will turn out to be the most economic choice for some

applications. Bearing in mind the special features of such systems, it appears reasonable to assume that they will be competitive under the following circumstances:

- low labour cost (more time required for operation and service is then not so important);
- short to intermediate annual operating time (low capital cost is then important, frequent service and maintenance less important);
- local manufacturing desirable (vehicle type systems require less well equipped workshops);
- remote sites (transport costs and site assembly costs can be reduced with compact and lightweight systems);
- mobile plant needed (compact and lightweight plants can be trailer mounted).

Two stationary power plants using vehicle type systems similar to the standard designs described in section 3.2 have recently been built and operated in Sweden.

One with a power output of about 30 kW has been built by "Gotland Gengas" and is used at the Royal Institute of Technology in Stockholm by the Beijer Institute-for tests with various fuels. No operational problems have been encountered with wood as fuel.

The other stationary plant is a prototype for a commercial plant with a power output of 40 kW built by Elektromatic Power Generation AB. It has been operated for several hundred hours at a sawmill, using wood chips as fuel. Modifications mainly aimed at a simpler control system are now being considered.

The experience gained from the operation of these two plants appears to verify that vehicle type systems can also operate satisfactorily in stationary applications. Whether such systems are more or less economic than systems designed specially for stationary use, such as those described in Chapters 4 and 5, or not, can only be established through more extensive operation under field conditions and will probably depend on the particular circumstances of each case.

3.6 Operating hazards

In this chapter the reasons for the Swedish interest in wood gasifier systems for vehicles has been explained, and the recent experiences from practical use of vehicles operated on wood gas summarized. It is believed that these experiences could be of interest for energy planning in other countries with a similar high dependence on imported fuels for the transport sector, and that the technology might be economically interesting for regular use under some of the circumstances outlined in Section 3.4.

It must, however, also be understood that use of producer gas vehicles involves certain risks. These have been described in Chapter 2, but it should be mentioned in this context that the experiences in Sweden of a rapid introduction of producer gas vehicles at the beginning of the Second World War were fairly unfavourable. There were several fatalities caused by carbon monoxide poisoning and a marked increase of the frequency of car fires. After enforcement of strict safety regulations, and strenuous efforts to educate drivers, these types of accidents became less frequent. The number of persons annually diagnosed as suffering from "chronic effects" of producer gas poisoning nevertheless increased. In total about 10000 persons in Sweden were recorded as cases of chronic poisoning during the period 1941-1945. It should be understood, however, that the symptoms do disappear after a time if a

person suffering from poisoning is no longer exposed to the gas. There appears to be no permanent damage, but poisoning is still a problem because of lost working days.

It is possible that this experience was a result of the habit of bringing vehicles indoors in the winter to facilitate starting and that the risks may be less in a warm climate, but it appears to be very important to minimize the exposure to gas of drivers, passengers and persons working in garages and service workshops. The least that can be done to avoid similar unfavourable experiences is to follow the safety regulations developed in Sweden for installation of producer gas systems in vehicles. A translation is provided in (23). If vehicle gasifiers are introduced on a large scale without adequate precautions, there is a real possibility of unnecessary human suffering and economic losses. Government control of any producer gas vehicle programme therefore appears to be necessary.

Chapter 4 - A small wood gas power plant at a sawmill in Paraguay

As a result of the sharp rise in petroleum prices during the 1970's, large areas of Paraguay, located far from the electric supply network, found themselves at a disadvantage. Transport rates increased considerably, adding further to the high cost of electricity generated by small units fuelled with gasoline or diesel.

The sawmill industry is fortunate in having the option of reducing its costs through increased reliance on wood-based energy and in 1978 the managers of the Sapire sawmill, located in southern Paraguay, decided to install a wood waste gasifier for the production of electric energy. It was necessary to identify a gas producer with flexibility of power output and suitable for operation by mill staff and labour already employed.

The specifications for the purchase of the equipment were the following:

1. A very sturdy low-speed engine with simple mechanics.
2. A gasifier that could use sawmill wastes of variable size and moisture content but at the same time be able to produce good quality gas for the engine.
3. Equipment with excess capacity to allow for flexibility in operation and to provide for the expansion of power production capacity in the future.
4. Provision for regulation of fuel consumption.
5. Design of wood gas generator suitable for operation by local workers and repair by rural mechanics, if necessary.
6. The equipment should meet industrial safety regulations and not cause environmental pollution problems.
7. Easily obtained spare parts, preferably from local suppliers.

In this chapter the experiences of the first four years of operation (up to February 1983) of the plant installed at the Sapire sawmill will be summarized.

The experience has been very favourable. After four years of operation the owner of the Sapire sawmill reported a satisfactory financial return, as the savings in petroleum products

enabled him to recover the investment (equivalent to US\$ 16900) in a year and a half. He has also reported that other sawmills have imitated him. Equipment handling and maintenance has presented no insuperable problems.

4.1 Description of the wood gas power plant

Figure 4.1 shows a schematic flow diagram for the electricity generation process. A more detailed flow diagram for the gasifier system is shown in Figure 4.2

Table 4.1 summarizes technical data for the plant.

Table 4.1 Technical data of downdraught wood gasifier power plant at the Sapire sawmill

Electric generator capacity	40 kW
Engine power	90 HP
Electric generator work hours per day	14
Daily power consumption of sawmill	463 kWh
Waste wood consumption per kWh	4.1 kg
Maximum waste wood moisture content	37% (dry)

4.1.1 Fuel supply

The sawmill is located in a forest area with abundant wood. The roads in this area are unpaved so the sawmill keeps stocks in a log yard to maintain the supply of raw material during rainy periods.

The wood supply for the gasifier is completely covered since it comes from the sawmill wastes. On average, these wastes amount to 35% of the log input, a quantity exceeding the needs of the wood gasifier (about 570 t/year). There is thus no need to economize on the fuel and in fact as much as possible is used so as to reduce the area needed for storage.

Table 4.2 shows the wood species used as gasifier fuel and the bulk densities of the corresponding wood chips.

Figure 4.1 Flow diagram for the gasifier system of the power plant at the Sapire sawmill.

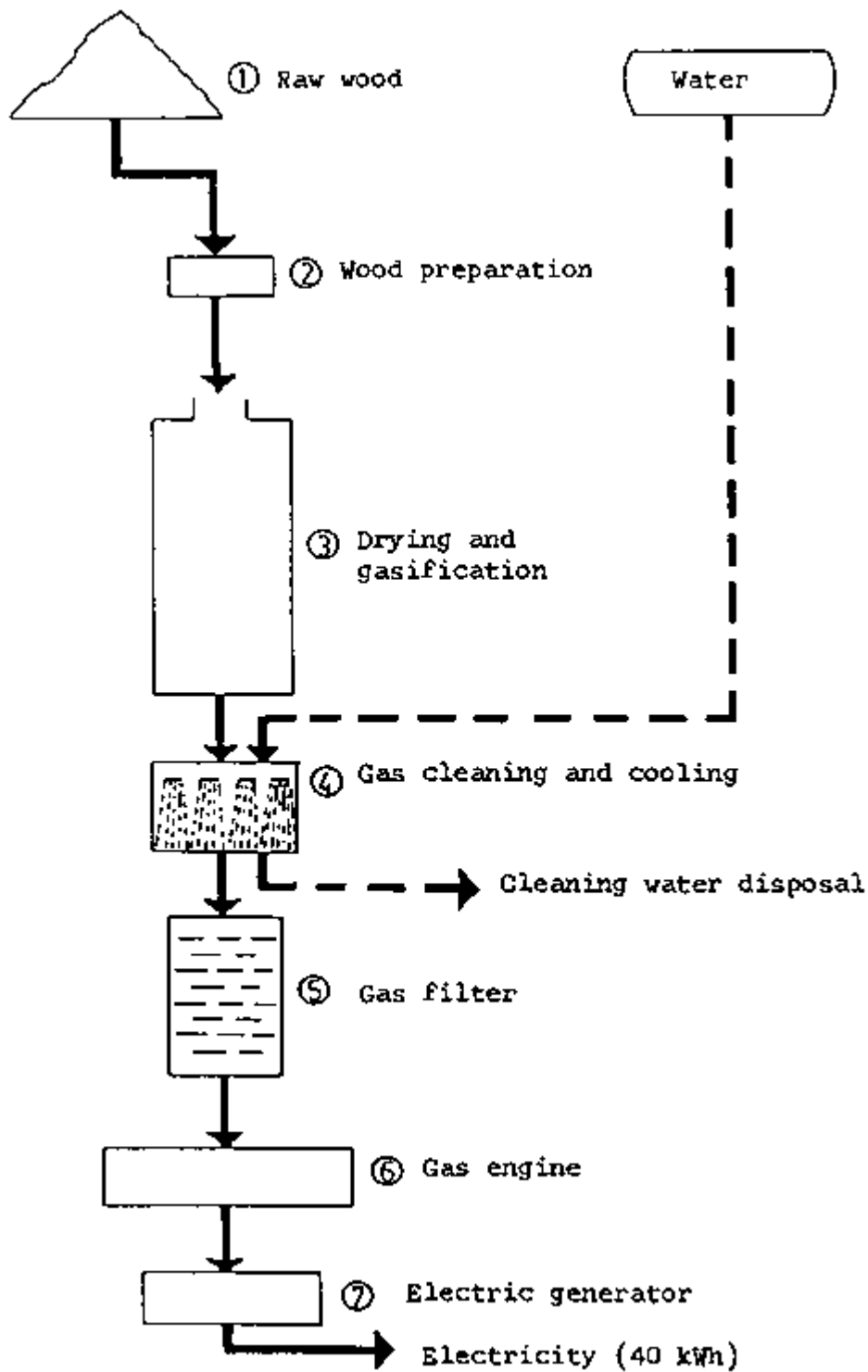

Table 4.2 Wood chips utilized for the gas producer

Name of Wood		
<u>Common Name</u>	<u>Botanical Name</u>	<u>Bulk density (kg/m)</u>
Palo Rosa	Aspidosperma peroba	861
Peteriby	Cordia mellea	543
Lapacho	Tecoma ipe	993

Cedar	Cedrella fissilis	554
Guacá	Ocotea puberula	448
Guatambu	Aspidosperma Austr.	883

The maximum dimensions of the wood fuel are 40 x 40 x 5 cm, i.e. the largest that can be fed into the loading chute of the gasifier, and smaller pieces, down to the size of a matchbox, are all accepted. In theory, about ten percent of shavings and sawdust can be included, but in practice this has produced poor results because the sawmill has an earth floor and dust tends to be swept up with the wood waste.

The maximum moisture content recorded was 37 percent, decreasing with size and the length of time the logs are stored before conversion. The moisture content therefore varies with sawmill operations and the seasons.

Variations of wood moisture content below the maximum do not affect the quality of fuel gas because the feedstock dries in the bunker section of the gasifier before it reaches the pyrolysis zone.

4.1.2 The wood gasifier

The wood gas generator consists of a unit with sheet iron walls 6 mm thick lined on the inside with bricks having 50 percent alumina (Al_2O_3) content. It has a total height of 3600 mm and its external diameter is 1400 mm. The fuel (wood) loading chute has a diameter of 400 mm. The reactor has cast iron grates installed 300 mm from the bottom. These grates are set 20 mm apart and have a lever movement system for removing ashes. Under the grates, 150 mm from the base, is a water cooling system with a three-fold function as follows:

1. Hydraulically closing off the area where the ashes fall out to prevent the combustible gas from leaking.
2. Cooling the grate and lever area.
3. Draining off the ashes with water.

Figure 4.2 Sketch of the wood gasifier at the Sapire sawmill

The gasifier has eight two-inch diameter air entrance openings. Four of these are separated at equal intervals of 1800 mm from the bottom. The remaining four are separated in the same way but at 1320 mm from the bottom (see Figure 4.2).

The gasifier, being moderately large, is able to accept pieces of wood varying in size and moisture content. The wood load forms a column in which carbonization takes place at the bottom and the convected heat dries the pieces at the top. One fuel load lasts for approximately fourteen hours and can be replenished during operation since the cover of the chute is always left half open.

The moisture content of the fuel should be low, preferably below 25 percent, so that effective oxidation of the various pyrolysis products can take place in the oxidation zone. A good quality fuel gas results.

The ash content is 0.7 to 0.9 percent of the weight of the dry wood. During gasification most of the ash reaches the grate where it falls into a sheet of water flowing from the cooling apparatus and is disposed of down a drain. A small part of fly ash is retained in the gas and is removed by cooling.

4.1.3 Wood gas cooling and washing installations

From a sheet iron receptacle 600 mm in diameter by 1300 mm in height a half-inch water tube with a disc attached at the end having holes like an ordinary shower, sprays water like rain on the hot gases. The water is then discharged into another receptacle where it becomes atomized by an electrically driven fan turning at 1500 rpm. The same water is then discharged by gravity into the bottom of the gasifier where, by passing through a row of bricks, it makes an hydraulic seal to prevent the combustible gases from escaping. Lastly, the water circulates, drawing the ashes into drains. The final temperature of the cooling water fluctuates between 75° and 85 C.

4.1.4 Wood gas filter

The gasifier has a cylindrical filter 2650 mm high by 800 mm diameter. The cylinder is filled with pieces of softwood 35 x 8 x 7 cm in size, reaching to the top of the gas outlet to the engine (see Figure 4.3). The large volume and large surface area of the filter provide an effective cooling system for the gas which is fed to the engine at about 45 C.

Figure 4.3 The gas filter. (Filter material: pieces of softwood)

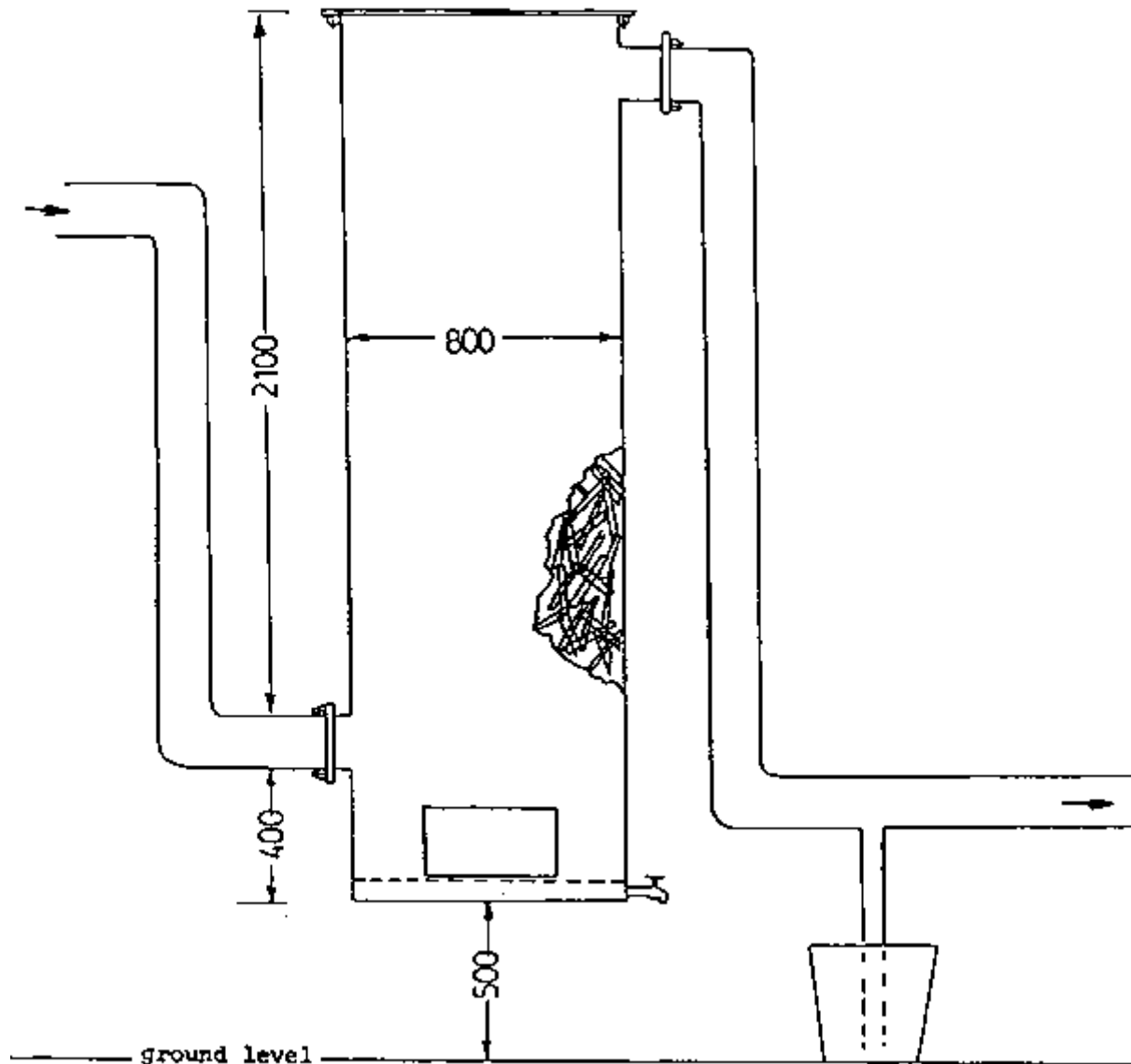

The construction of the filter is simple and practical and ensures a long working life, the filter material being changed every two years of operation.

4.1.5 Engine and electric generator

The generator and engine group consists of used equipment which has been completely renovated. The engine is a one-cylinder "Deutz" rated at 90 HP at 150 rpm. Because of its slow action and extreme sturdiness it has an estimated working life of 40 years. The generator, manufactured by AEG, is rated at 40 kW at a speed of 1500 rpm.

4.2 Operating experience

The plant was commissioned in 1978 and had operated for 8000 hours up to January 1983.

The total energy production during that time was 160000 kWh.

4.2.1 Fuel consumption

The average wood consumption of the plant is 4.1 kg/kWh. This is a relatively high figure but it is acceptable indeed desirable - because of the need to keep the sawmill and its surroundings clear of wood waste. Should the need arise, consumption can be reduced by control of the air flow in the gasifier.

4.2.2 Manpower employed and operating procedure

The equipment is serviced by one operator on a part-time basis, continuous attention is not needed. In addition, three employees prepare the fuelwood pieces and stoke the gasifier.

The main operations on any one day are as follows:

1. Turning on an impeller fan to start gas production. After some minutes the combustibility of the gas is tested by lighting it with a small flame.
2. Turning on the gas producer engine to supply power to the sawmill.
3. Starting the water pump which supplies the sawmill with the cooling water for the gasifier/generator and the households.
4. General maintenance, including lubrication and charging the compressed air tank in readiness for the next start-up of the engine.
5. Cleaning of the gasifier and preparation of fuel in sizes suitable for the loading chute. Refuelling of the gasifier is done at noon, half an hour before the end of the first period of work, and again in the evening before the end of the shift.
6. During the afternoon, the operators inspect and service the equipment - lubrication, storage batteries, cooling water, ash outlet, filter outlet, gas temperature.
7. The sawmill's work day ends at 18.00 hours but the engine and generator continue to operate until 22.00 hours for the benefit of the small village. Preparations for this have been completed during the day, and the operator makes a visit every hour until he stops the machine at 22.00 hours. The gasifier has a sufficient reserve for an immediate start the next morning.

4.2.3 Safety

The installation has the following features which help to minimize the usual hazards of gasifier operation:

1. Excessive internal pressure cannot build-up because the lid of the feeding chute is permanently left half-open. Should it be operated closed, a quick-release mechanism can be used to relieve pressure.
2. The gasifier is housed in an open shed so that concentrations of carbon monoxide cannot develop.
3. Gas is fed to the engine by suction. If leaks develop in the system the gas cannot therefore escape into the air.
4. Ashes and cinders are discharged onto a water bed so there is no risk of fire from these.

5. The gasifier is sited at a sufficient distance from the sawmill to avoid heating the workplace.

4.2.4 Environmental impact

A strict analysis of the environmental impact of the gasifier has not been carried out but, as noted above, simple precautions have effectively eliminated the risks of carbon monoxide poisoning and fire. Moisture and smoke are vented through the gasifier chimney which is sufficiently high not to cause pollution. Waste water and ashes (1000 l and 19 kg a day) are discharged downhill to a remote swamp. Finally, the exhaust gas of the engine appears to be cleaner than that of an engine operated by diesel fuel.

4.3 Economic evaluation

4.3.1 Capital investment

The initial investment, shown in Table 4.3, was ₪ 2131700 equivalent to US\$ 16918 or 423 US\$/kW. Note that the engine and generator were used and renovated.

An extension of the power line of 150 m to family homes is also included.

4.3.2 Operation and maintenance costs

The person responsible for operation and maintenance of the gas producer equipment receives a monthly salary of ₪ 70000. His basic pay is ₪ 60000 and he receives an additional ₪ 10000 to watch and stop the machine at night while electricity is supplied to family homes until 22.00 hours. Taking 25 work-days a month as the base, the daily wage is ₪ 2800.

Net operating and- maintenance time on the gas producer and electric generator engine group corresponds to a half day's work of the operator, the other half being spent on maintenance tasks elsewhere in the mill. Therefore, only 50% of the mechanic's salary, or ₪ 1400 per day, is allocated to the gas producer and electric generator group.

Cost of lubricants is about ₪ 0.84/kWh or 0.0067 US\$/kWh.

Spare parts for the engine and gasifier system have an average cost of ₪ 174424 annually or 13 percent of the basic investment cost of the equipment (₪ 1352100).

Note = 1 US\$ = 126 ₪ (1982)

Table 4.3 Capital Investment for the electricity generation unit at the Sapire mill

	G	US\$/kW
Land (100 m ² at 100 G/m ²)	10000	2
<u>Civil Engineering Works</u>		
A 50 m ² ceiling with iron columns, No. 26 sheet-zinc roof and cement floor 15 cm thick reinforced with 4.2 mm iron bars at G 4000 per m ²	200000	40
42 m ² brick wall 0.30 m thick at G 1300 m ² , 4 m reinforced concrete for installation of engine platform	54000	11
Electric generator and gasifier at G 20000 m	80000	16
<u>Electric Installations</u>		
Electric installations and panel. Feeding outlets and 150 m extension line to family homes.	140000	28
<u>Machinery and Equipment</u>		
90 HP Deutz engine and 40 kW A.E.G. electric generator	560000	111
Wood gasifier with accessories (gas cooler, filter, piping, etc.)	792100	157
<u>Transport and Insurance Costs</u>	45000	9
<u>Assembly and Testing Costs</u>	250000	49
Total Investment	2131700	423

4.3.3 Fuel costs

Residues at this sawmill have no market and so no commercial value, and no cost is applied to the raw material as such.

Preparation and handling of the fuel for the gasifier do, however, incur a certain cost. At the Sapire sawmill, the cost is composed as follows:

<u>Number of employees</u>	<u>Hourly wage rate per employee</u>	<u>Total work hours per day</u>	<u>Daily cost of labour to provide fuel</u>
3	G 250	3	G 750
i.e. sawing machine, electricity, etc.			G 104
Total cost of fuel preparation handling wood and loading gas producer/day.			
			G 854

COSTS PER DAY

Average wood consumption 1898 kg
 Total wood handling and loading costs ₱ 854
 Electric energy produced kWh 463

COSTS OF CUT WOOD PER KG - $\frac{854}{1898.3} = \text{₱ } 0.45$

COST OF CUT WOOD PER kWh - $\frac{854}{463} = \text{₱ } 1.80$

4.3.4 Total operating costs

Table 4.4 shows the total monthly and annual operating costs. The marginal cost for electricity generation is 8.17 ₱/kWh or 0.064 US\$/kWh.

Table 4.4 Summary of Operation and Maintenance Costs on the Gas Producer and Electric Generator Engine Group

<u>Cost Item</u>	<u>Monthly Costs</u>	<u>Annual Costs</u>
	₱	₱
<u>Operating Labour</u>		
1 machine operator	35000	420000
Social contributions and benefits		16800
	Annual total	588000
<u>Fuels</u>		
Fuel wood, 569490 kg at 0.45 ₱/kg		
Annual fuel cost		256200
<u>Lubricants</u>		
₱ 0.84/kWh		
Annual cost of lubricants		116676
<u>Engine, Generator and Wood Gasifier Spare Parts.</u>		
Annual cost of spare parts		174424
		1135300
Annual electricity production kWh		138900
Marginal generation cost ₱/kWh	₱/kWh	8.17

4.3.5 Costs for electricity generation for family homes of sawmill personnel

The annual consumption of electricity in the five homes of sawmill personnel, supplied with electricity free of charge is 4500 kWh. The annual cost for this, estimated from the marginal cost of electricity generation given above, is ₱ 36765 or US\$ 292.

4.3.6 Comparison with other alternatives for the electricity supply

Table 4.5 shows a comparison between the fuel costs for use of wood residues and gas oil for electricity generation at the Sapire sawmill.

The annual saving on fuel costs is G 1910640 or US\$ 15164. Deducting the cost of labour, lubricants and spares shown in Table 4.4 (and taking no account of such costs for the diesel plant) the total annual saving with the wood gas power plant is G 1031540 or US\$ 8186 as compared with the cost of diesel fuel alone.

Comparing this with the capital investment (see Table 4.2) of G 2131700 shows that the pay-back time is less than 2.5 years for an interest rate of 10%.

After more than four years of operation it is clear that the utilization of a wood gas power plant is a very profitable solution to the energy supply problem of this isolated sawmill.

Table 4.5 Comparison of Fuel Costs for Wood Gas Power Plant and Diesel Power Plant

Fuel consumption and fuel costs:		
Wood consumption	kg/kWh	4.1
Wood cost	G/kg	0.45
Gas oil consumption	l/kWh	0.26
Gas oil price	G/l	60.0

Engine Work-time	kWh Production	Gas Oil Consumption	Cost of Gas Oil	Fuel Wood Consumption	Cost of Fuel Wood	Net Savings Using Fuel Wood
		(l)	G	(kg)	(G)	(G)
1 day (14 h)	461	120	7223	1900	854	6369
1 month (25 days)	11575	3009	180570	47460	21350	159220
1 year (12 mths)	138900	36114	2166840	569500	256200	1910640

Chapter 5 - A small gasifier power plant in Sri Lanka

The gasifier power plant described in this chapter was built by "Biomass Energy Consultants and Engineers" of The Netherlands. Within the context of the "International Producer Gas Conference", the plant was installed at Peradeniya University, Sri Lanka, for use as a demonstration unit during the course on producer gas technology.

By the end of November 1982, it was transferred to the Giriulla Mills for generating electricity based on coconut shells and providing power to part of a coconut desiccating mill.

Operational data are restricted to the period during which several biomass fuels were tested at Peradeniya University and to the first operational months at Giriulla Mills.

Since the beginning of January 1983, the unit has been operating 20 hours daily, 6 days a week, except for holidays. Total operational time of the unit (including test runs in the Netherlands, test runs at Peradeniya University and operation at the Giriulla Mills) is approximately 1200 hours.

5.1 Description of the plant

5.1.1 General system layout

A schematic flow diagram for the power plant is shown in Figure 5.1.

The rated power output is 32 kW.

5.1.2 The gasifier

The gasifier is of the down-draught type with five air entrance openings. The throat diameter is approximately 15 cm, and the general dimensioning of the unit is in accordance with the design rules given in Chapter 2.

The throat is made from refractory cement. The inner side of the bunker is air-lined with this material. The hand-operated grate is positioned approximately 20 cm below the smallest cross-sectional area of the throat.

The gasifier is equipped with a double-valve hand operated filling sluice. '

Product gas exchanges heat with incoming air before it is passed on to the gas cleaning section.

[Figure 5.1 Flow diagram for producer gas power plant at the Giriulla mill](#)

The gasifier is equipped with an acoustic fuel level indicator which gives an alarm at the time refuelling is required.

Gasifier outlet temperatures as well as the pressure drop over the "throat" of the unit can be measured. Average values obtained with the different types of fuels tested are given in Table 5.1.

5.1.3 Cyclone

Coarse particles are separated from the gas stream in a high efficiency cyclone separator. Entrained ashes from the gasifier are collected in an ash bin which can be opened at the bottom for regular cleaning.

5.1.4 Impingement separator

Intermediate size particles and most of the fines are removed from the gasifier in an impingement separator of special design. This separator is insulated so as to avoid condensation of vapours and to allow passage of hot gas (above 150°C) to the glass fibre cloth filter.

5.1.5 Glass fibre cloth filter

To guard the engine against any solid material, the product gas is passed through a glass fibre cloth filter, which removes any solids that have slipped through the previous filter sections.

In order to maintain the temperature above the dew-point of the gas and to avoid condensation (approximately 80°C) this filter is also insulated with rockwool and an aluminium lining.

Both the impingement separator and glass fibre cloth filter are equipped with water gauge manometers in order to permit the continuous monitoring of pressure drop caused by fouling of the filtering devices.

Originally, the glass fibre cloth filter was equipped with a safety condensate outlet. In Giriulla it was found that such a device was unnecessary. Because some water was condensing in the connection pipe between cooler (see below) and engine air inlet manifold, the drain vessel was removed from the filter box and put in the connection pipe, where it worked better.

5.1.6 Cooler

The cooling section consists of a tubular heat exchanger. Condensate can be tapped from the cooler by means of two drain vessels, equipped with safety taps, similar to the one described above. Cooler outlet temperatures vary between 30° and 50°C, depending on environmental conditions (temperature, wind) and engine load.

5.1.7 Engine and alternator

Gas is introduced into the engine after being mixed with air in a gas carburettor.

Engine speed is controlled by-means of a Barber-Colman electronic engine speed regulator, which controls simultaneously a gas valve and an air valve. The engine speed is kept constant at 1500 rpm.

The system is equipped with an International Harvester gas engine (compression ratio 9.5 : 1), with a cylinder volume of 9.9 dm³.

The alternator is a short-circuit proof, self-excited internal pole machine in synchronous construction with the following specifications:

Power output: 40 kVA
 Power factor: cos phi 0.8
 Voltage: 380/220 V
 Frequency: 50 Hz

The system is able to follow a step load change of 20 kVA with constancy of + 5 percent.

The alternator is equipped with a switchboard containing:

- 3 ampere meters
- 1 voltmeter
- 1 frequency meter
- fan control button
- ignition button
- start-up safety switch
- power socket CEE (5 pole) and power socket DIN 49462

5.1.8 Start-up fan and flare

A 24 V fan is provided for use during start-up of the installation.

Initially the product gas is flared. The flare is provided with a water lock in order to prevent backfiring.

During operation of the installation the fan batteries are continuously recharged.

Table 5.1 Performance Data for the Gasifier

Date	Fuel		Gasifier		Filter I		Filter II		Eng-Alt Power output	Overall efficiency	No. of operational hours
	Type	cons.	ΔP 1/	T_{out}	ΔP 1/	ΔP 1/	T_{out}	T_{in}			
	(++)	kg/h	cmVg	$^{\circ}C$	cmVg	cmVg	$^{\circ}C$	$^{\circ}C$	kVA	%	
02/11/82	I	-	8	475	-	78	140	43	32	-	2
02-12/11/82	II	50	15	400	30	35	110	42	33	16	26
15-16/11/82	III	50	20	380	-	45	120	43	33	20	10
20/11/82	IV	45	15	370	-	35	110	46	32	17	5

b) Location Giriulla Mills

from 10/12/82 to 30/04/83	IV	35	20	390	30	40	110	45	25	16	1 000
---------------------------------	----	----	----	-----	----	----	-----	----	----	----	-------

- (++) I : coconut husk
 II : mixture of charcoal and rubber tree wood
 III : coal dust briquettes
 IV : coconut shells

1/ water gauge system

5.1.9 Safety devices

The reactor and the filter box are provided with explosion discs.

Operating the start-up fan is not possible with valve E (see Fig. 5.1) opened, thus preventing air from being sucked into the system.

The engine is automatically stopped on loss of oil pressure.

5.1.10 Auxiliaries

The installation is provided with a suitable staircase and fuel feeding platform, in order to permit easy fuel delivery to the gasifier via the double-valve filling sluice. The whole installation is mounted on a base frame and can thus be transported without being dismantled.

5.2 Operational procedures

5.2.1 Start-up

In order to start-up the unit, the following operations have to be performed:

1. Closing of valve E and opening of valve D (see Fig. 5.1).
2. Opening of the reactor ignition port.
3. Starting the fan by switching the fan button control.
4. Lighting of a piece of paper, that has to be put into the reactor ignition hole. This paper will be sucked into the gasifier and will ignite the charcoal present in the reactor. It takes about a minute before the charcoal inside the reactor is burning and the ignition hole can be closed.
5. Opening of the gasifier air inlet. Product gas is now escaping through the flare. The gas must be flared for about ten minutes, before the engine can be started.
6. Switch the fan button to out position, close valve-D and open valve E.
7. Put the air inlet valve to the engine into the half-open position.
8. Close the reactor air-inlet for a short period to create a slight overpressure in the system.
9. Start the engine by pushing the starter button on the control panel.
10. Leave the engine running unloaded for a period of about five minutes.

The whole starting-up procedure takes about twenty minutes.

5.2.2 Closing down

1. Switch off the engine's ignition.

2. Close valve E.

3. Leave the gasifier air inlet open for a short period in order to release the pressure build-up caused by continuing pyrolysis of the fuel. Be aware that poisonous carbon-monoxide is being produced.

4. After a few minutes close the gasifier air inlet in order to avoid continuous combustion of the reactor's fuel content.

5.2.3 System maintenance

When operating on coconut shells it proved necessary to remove the ashes from the bottom of the reactor every ten operational hours.

The ash bin of the cyclone had to be emptied approximately every forty hours.

From the pressure drop over the impingement separator it became clear that cleaning of this filtering device was necessary approximately every 100 hours. Cleaning of the filter proved to be fairly difficult because of the construction which allows access only at the top of the device. The solution was found by removing the dust by means of a vacuum cleaner.

From the pressure drop over the glass fibre filter it was concluded that cleaning of this device is necessary approximately every 100 operational hours. Cleaning proved to be a rather tiresome procedure because the top of the filter had to be removed. Removal of the heavy top lid involves at least three persons or alternatively a pulley has to be installed.

The above maintenance can of course be undertaken only when the system is out of operation.

Condensate water must be removed from the condensate drain vessels approximately every five hours. This is a minor task and because of the special construction of the drain vessel taps it can be performed when the system is in operation.

The times given for maintenance intervals depend not only on the operation time of the system but on the engine load which is of equal importance. Because the average engine load during operation at Giriulla mills was on the low side (see below), it is entirely possible that the intervals between maintenance will be shorter when the system is run under full load.

5.3 Operational experience

5.3.1 Operating record and observations on the performance

The biomass gasification plant was in operation intermittently for about forty hours in November 1982 on several fuels at Peradeniya University.

Operational data are presented in Table 5.1

Some tendency to slagging was observed when operating on coconut husks, rubber tree wood and coir dust briquettes. Quite possibly this was due to a relatively large amount of sand that was introduced into the gasifier together with the fuel. Regular grid rotation prevented excessive pressure drop across reactor and bunker, and bunker flow could be maintained at the de-sired levels.

At the end of November 1982 the unit was transferred to Giriulla Mills where it has since been operating, fuelled by coconut shells.

Operational data for this period are also summarized in Table 5.1. The system is producing power for six desiccating motors at a load of up to 30 kVA.

The system can follow a step load change of 20 kVA.

Collected condensate appears to be a clear liquid, indicating that only traces of tarry components are present in the producer gas.

The overall system efficiency was between 15 and 20 percent, as a ratio of output electrical energy to input biomass energy.

System efficiency is of course dependent on fuel characteristics, load characteristics and environmental conditions. The highest efficiency was obtained when operating on coir dust briquettes; the slagging tendency of this fuel has to be further tested in an extended run, in order to decide whether automatic and continuous grid rotation is necessary.

At Giriulla Mills the system was continuously operated for about 1000 hours.

From Table 5.1 it is clear that on average the installation was operating at 50 percent of its full capacity. From the more detailed data it may be concluded that operation periods at loads of around 33 percent of full capacity are frequent.

5.3.2 Disturbances of the operation

On 19 January 1983 the engine stopped and thereafter it was not possible to operate the starter motor. The motor was replaced and the engine then started easily.

It is not clear whether this problem stemmed from a defective engine ring gear (which may have been faulty from the beginning) or whether the problem has to do with the use of producer gas, which often calls for somewhat prolonged use of the engine's starter motor.

The gasifier operated normally during January and February 1983. However, on several occasions the gasifier outlet temperature rose above 475°C, a phenomena which was not accompanied by higher pressure drops over the gasifier and the filter section. Rotating the ash grate did not result in a reduction of the outlet temperature. The engine was stopped for one to two hours on these occasions.

Later (see below), it was possible to attribute the fault to air leakage into the gasifier.

On 4 February, it was noticed that the frequency of refilling with shells had increased from the normal 15 minutes to 5-10 minutes. Since the weather had been exceptionally hot and dry from late January onwards, the shells were wetted before loading into the gasifier. Thereafter the frequency of filling returned to the original 15 min.

On 11 February, the engine started misfiring (speed equivalent to 47-50 Hz). Upon replacement of the spark plugs with new ones the misfiring of the engine stopped.

On 21 February the temperature of the gasifier outlet rose to 500 C. It was noted that tar was leaking out of the gasifier safety hatch door. Because it was suspected that air was being

sucked in through this safety hatch, thus causing the temperature rise, the door was tightly closed. This brought down the gasifier outlet temperature to the normal value of 430°C.

It was planned to replace the spring-loaded safety hatch door by a metal explosion disc, as in the bag house filter.

On 25 February it was noticed that the inside of the inspection hatch (at the gasifier hearth zone) had deteriorated. Therefore an air leak was suspected through this door. A repair was carried out with mild steel plates as there was a danger of the refractory lining cracking and falling down. The sealing on the door of the inspection hatch was cleaned. Inspection a week later showed that the mild steel plates were holding out.

On 1 March it was noticed that the refractory lining had flaked off at the top and bottom edges. This may have been caused by the frequent cooling/heating cycles. No measures were taken and the situation seemed to remain stable.

Inspection of the ash pit on 23 March showed a semisolid slag as if the ash had burned in the ash pit. Air must therefore have been leaking into the gasifier ash-space either through the ash outlet or through the grate seal. The grate seal was suspected as it could not be tightened. The Giriulla mills-engineer fitted an additional sleeve after which there were no further problems.

In February the average engine inlet temperature rose to 50°C, as compared to 42°C in January. Probably this was due to the high ambient temperature in February (on 11 February it was 37° C in the shade and 39°C inside the gasifier shed).

In May 1983 the engine started misfiring again. A change of spark-plugs had no effect. Upon dismantling of the engine it was found that the pistons were covered with carbon 1 mm thick. Also it was noted that the engine inlet manifold was covered with a 2 mm thick semi-solid layer of either tar or dust/water slurry. The engine's valves appeared to be clean. The misfiring of the engine was attributed to pre-ignition caused by carbon build-up in-the cylinders.

It is not clear whether the tar production results from the rather low loads at which the engine is now and then operated or stems from an incorrect installation of-the glass fibre cloth filter.

5.3.3 Desirable modifications

The first months of operation revealed the following shortcomings in design and lay-out:

1. The accessibility of the impingement separator is poor and a vacuum cleaner is required to remove the dust.
2. The bag house filter maintenance is difficult. Removal of the top lid requires removal of a flange and the lid is too heavy requiring either three people or a mechanical device to raise it.
3. The grate shaker is not convenient to operate. A lever system which could be operated while standing up would be an improvement.
4. Condensate from the cooling tubes collected in the piping close to the engine inlet. It was necessary to fix an additional drain tank to this pipe.

5. Refractory lining flakes off, probably as a result of the frequent heating/cooling cycle. This could be avoided by supporting the base of the lining with a metal flange.

6. Hot radiator cooling air from the engine is partially directed towards the cooler of the gasifier. This diminishes the effectiveness of the gas cooler.

7. The fuel hopper is too small for coconut shells. It is inconvenient to have to refill the fuel bunker every 15 minutes.

8. The engine's maximum power output is too low. Although the system is designed to deliver 40 kVA, it is possible to get 35 kVA only. This is probably due to the unorthodox system of engine speed control, which controls the gas and the air input to the engine simultaneously, instead of using the normal system where only a gas/air mixture valve is controlled.

Also from general principles it seems possible that the air/gas mixing in the engine's simple gas/air carburettor is not complete, as a result of which some cylinders may get too rich and others too poor mixture.

5.4 Economic evaluation of electricity generation costs at Giriulla mill

Overall power costs of the system can be calculated on the following assumptions:

System cost	US\$ 32000 (Hfl. 90000)
System life-time	6 yrs
Interest rate	10%
Maintenance costs	10 percent per year of initial investment <u>1/</u>
Additional labour costs	1 man-yr
Coconut shell costs	US\$ 6.00/t
Operation	4000 h/yr

Those assumptions lead to the following breakdown of annual costs:

Annual Capital charges <u>2/</u>	US\$ 7350
Maintenance	3200
Additional Labour	700
Lubricants	1600
Fuel (140 ton coconut shell)	840
Annual Cost	US\$ 13690
Energy produced (4000 h x 20 kW)	80000 kWh
Unitary cost	0.171 US\$/kWh

Those costs compare favourably with a diesel generation system, for which the costs under comparable circumstances would be around 0.26 US\$/kWh.

1/ Assumed

2/ Annual capital charges are calculated using the relationship:

$$ACC = C \times \frac{i}{1 - (1+i)^{-t}}$$

in which:

C = capital costs

i = annual interest rate

t = lifetime of system

5.5 Concluding remarks

From the detailed discussion above it will be seen that a number of operational difficulties were encountered. Those problems are easy to solve and have been remedied in second generation installations.

A major problem could result from the slow carbon build-up in the engine's cylinders as a consequence of traces of tar or dust in the gas. Whether this is due to too low engine loads or to a defective glass fibre cloth filter remains to be tested.

The economy of the gasification system in Sri Lanka compares favourably with diesel-electric generating systems of the same size.

Chapter 6 - A 1.4 MW wood gas fuelled power plant in Paraguay

In Loma Plata in the Chaco region of Paraguay, the German company Imbert installed in 1983 a 1.4 MW power plant fuelled by wood-gas. Originally the plant consisted of two down-draught gasifiers, with a nominal gas-production capacity of 1800 m³/h each, but in October 1985 was equipped with a third gasifier of local design and manufacture. The gasifiers feed three Waukesha L7042 G gas-engine-alternator sets, with a generating capacity of 420 kVA each. The power plant supplies a private agricultural cooperative of small-scale industries, bakeries, dairies, schools and some 1,500 families with electricity.

Up till now (February 1986) the first two gasifiers have been in-operation for more than two years and the third for more than three months. The power-plant has been working without major problems and enabled the cooperative to develop and improve its economy through lower energy costs, increased electricity supply and new jobs.

The average wood-fuel consumption per produced kWh electricity has been 1.9 kg/kWh, with a fuel cost of 2.9 G/kg, compared to the cost of diesel oil, which has risen from 72 G/l in January 1984 to 127 G/l in December 1984.

In the following sections a more detailed description of the power-plant, the wood fuel preparation and the electricity production costs, as reported by Sonnenberg & al. (37) and Cañete (9), are presented.

A schematic layout of the Loma Plata power plant is shown in Figure 6.1.

In 1981 the Development Department of BNF (Banco Nacional de Fomento de Paraguay) in cooperation with the technical and administrative division of the Chortitzer Cooperative Committee in the Chaco region carried out a feasibility study of establishing an electricity generating power plant using wood-gas as fuel. The study included many fuel alternatives and concluded that the use of wood-gas would be the most feasible and profitable solution for the Chaco region.

Figure 6.1 Flow diagram for the wood-gas fuelled power plant at Loma Plata (3 Gasifier-engine units)

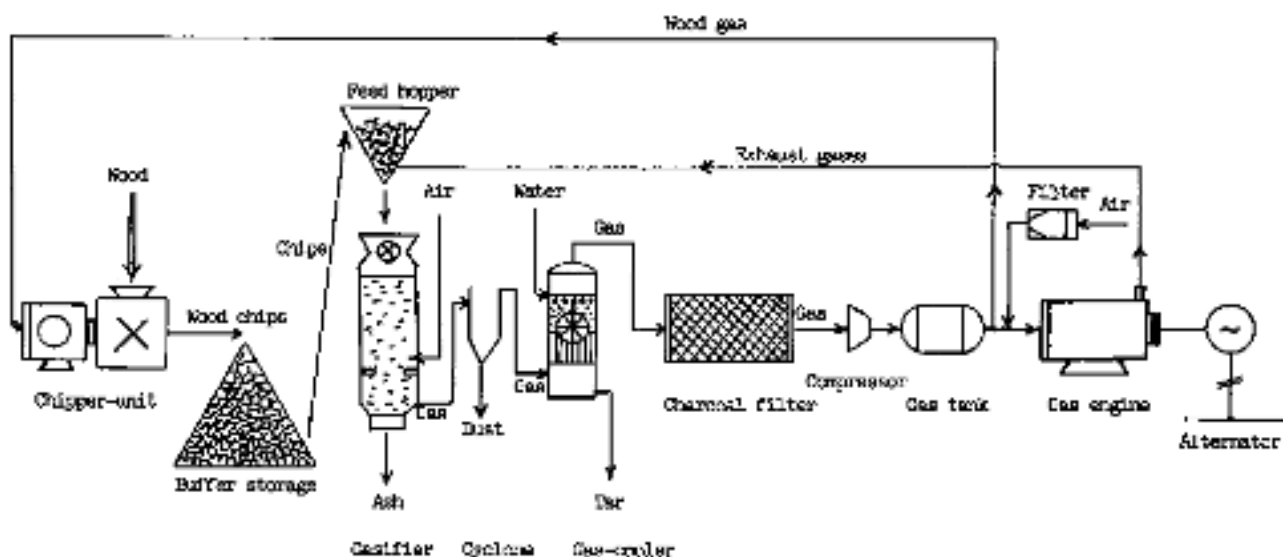

The conclusions were based on the following facts:

- 1) the possibility of avoiding the use of fossil fuels for electricity generation;
- 2) creation of new jobs in fuelwood harvesting, transportation and preparation;
- 3) utilization of the forest residues unsuitable for industrial processing;
- 4) reducing the costs of farmers preparing new agricultural land by having the possibility to sell the cut wood as fuel;
- 5) the fuelwood resources of the area will cover the needs of the power plant for a long time;
- 6) no need of good quality cooling- or boiler water;
- 7) avoiding the transportation of fuel oil over long distances, with continuously growing costs;
- 8) considerably lower costs per produced kWh electricity with wood-gas than with diesel oil;
- 9) savings of foreign currency both on a national and regional level, by decreasing the need for imported oil;
- 10) development of regional self-sufficiency in the zone, without being dependent on climate and oil supply (the routes are often closed because of rainfall), and improvement of the economy because of smaller oil bills for the power-plant and smaller electricity bills for the industry in the zone.

Leaning on the facts of the feasibility study the Chortitzer Cooperative decided to ask for a loan, to realize the wood-gas project, with an estimated total cost of 320 million €. This would be the first power-plant of this size in South America producing electricity with a biomass-based fuel.

The first two years of operation have created great interest among representatives of the government, technical institutions and both national and foreign agents and decision makers, who have paid frequent visits to the Loma Plata power-plant.

6.2 Wood-fuel supply and preparation

The wood-fuel for the plant is supplied from a 274000 ha large forest area, with an estimated total quantity of 57 million tons of fuelwood and a natural growth rate of 2 - 3 m /ha/a. Within the zone under influence the use of fuelwood has grown from 3300 tons in 1981 to 10500 tons in 1984. With the third gasifier taken into use, the Loma Plata power plant is projected to use approximately 15000 tons of fuelwood per year. The other biggest fuelwood consumers in the area are the peanut oil and cotton industries, brick and charcoal producers, bakeries and furniture manufacturers, consuming annually between 600 to 1100 tons each. Thus, the supply of fuelwood to the power plant will by all probability not be endangered in the near future. The fuelwood resources of the Chaco region are estimated to cover the needs of the power plant and the industries for more than 3000 years. The fuelwood is brought into the plant from an area of 45 km radius.

The fuelwood delivered to Loma Plata is mainly of Quebracho blanco origin. The diameter of the stems is between 50 and 250 millimetres. It is necessary to provide the gasifier with clean and fairly dry wood-fuel without stones, clay or extra mineral matter; otherwise the ash

in the gasifier becomes slag and disturbs the gasification process. Therefore an area with hard floor, for the feedstock preparation, is arranged near to the gasifier plant. It is recommended that trunks of wood are first cut to lengths from 1.5 to 2.5 metres for easier preparing and handling in the wood-fuel comminution system. To accelerate the drying process it is advantageous to split the stems in the open air. A simple hydraulic splitter is used. Before chipping, the moisture content of the fuelwood is on average 40-42% and it dries in sixty days in open air to 28% and covered by a roof to approximately 25% (see table 6.1). For practical and safety reasons the plant stores woodfuel for roughly three months consumption within the site.

Table 6.1 Drying properties of the fuelwood (9)

drying time (days)	open air M.C. dry (%)	covered M.C. dry (%)
0	40.7	40.7
15	34.2	30.7
30	32.3	29.5
45	29.9	27.2
60	27.2	25.2

The gasifier fuel should preferably be smaller than 70 to 90 millimetres in length of 300 cm in volume. A drum chipper, with a capacity of approximately 20 m³/h, and driven by a wood-gas engine (Mercedes-Benz, 110 kW power output) is used for this purpose. The chipper has a diameter of 1000 mm and rotates at 1000 rpm. By running it for 4 - 5 hours/day the required woodfuel amount for 24 hours operation can be produced. Table 6.2 shows a normal particle size distribution of the produced wood chips.

Table 6.2 Particle size distribution of the gasifier-fuel(9)

screen size (mm)	retention (%)
150 x 150	4.8
100 x 100	56.0
50 x 50	29.2
25 x 25	9.9
sieving loss	0.1

The bulk density of the wood chips is approximately 400 kg/m³ at 25% moisture content. From the chipper the wood chips are transported to a buffer storage with a conveyor. The capacity of this covered buffer is approximately 300 m³ and its surface area 200 m². The woodchips are loaded from the buffer storage into the feed hoppers of the gasifiers with the aid of conveyors. The feed hoppers are equipped to use the exhaust gases from the engines, to further reduce the moisture content of the wood-fuel. The moisture content of the chips decreases with 5-10% units after contact with the approximately 150°C hot exhaust gases during 12 - 15 minutes. An analysis of 15 samples of wood chips gave an average moisture content of 19.2%, with a variation between 10.2 and 28.7%. The size of one feed hopper is 8 m³, which will suffice for three hours operation, at full gasifier load.

6.3 Description of the down-draught gasifiers

The power-plant of Loma Plata is equipped with three downdraught gasifiers - two of Imbert design and one of local with a nominal gas production capacity of 1800 m³/h each. The

gasifiers are fed by means of conveyors from the day-hoppers which are installed at the front of the gasifiers in an underfloor pit (see figure 6.2). The wood-fuel is loaded from the feed hopper to the gasifier automatically, to match the gasifiers consumption and to balance the requirement of the wood gas engines.

The gasifiers operate at negative pressure, which results from the suction of either the gas engine or a gas blower. The total height of the Imbert gasifier is 7.5 metres and the outer diameter 2.1 metres. The third gasifier, which is of local design and manufacture, has a higher reduction zone, which enables the gasifier to operate at lower temperatures without tar entrainment in the produced gas.

Figure 6.2 Schematic Lay-out of the wood-fuel preparation and gasifier units (g)

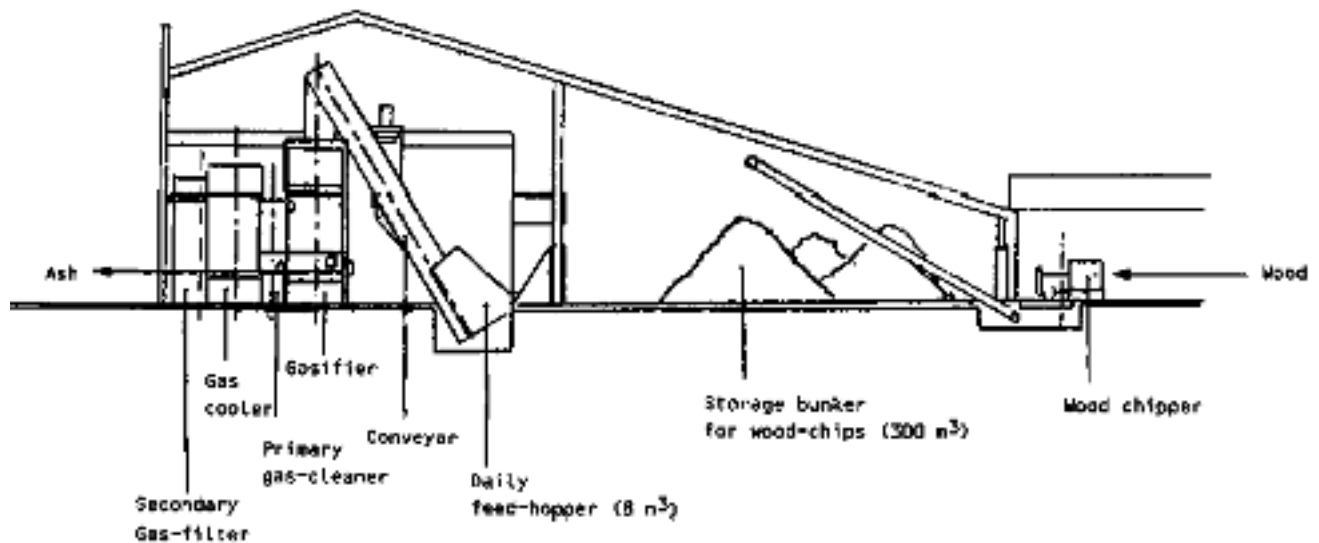

The wood descends through the gasifier by gravity. At start-up charcoal is loaded in and below the hearth zone, with wood on top. Lighting is done with some straw or a piece of paper. After start-up it only takes about five minutes for gas production to begin, because the charcoal reacts very quickly with air in the hearth zone. The total time of approximately 40 minutes is needed to achieve full gas production capacity. The air intake is provided by a system of pipes and nozzles, with preheating of the air through heat-exchange with the gas produced. Heat conservation is aided by insulation of the outer jacket. Figure 6.3 shows an extra air inlet device, that was installed to ensure complete cracking of the heavier hydrocarbon come portents. The gasifiers are designed to operate down to 25% of full load capacity. Sufficiently high temperatures in the oxidation zone give a gas practically free of tar.

If operation of the gasifiers is interrupted or terminated, the engines have to be turned off. But, if an appropriate temperature has already developed inside the gasifier, gasification re-starts immediately after turning on the suction blower, even after longer stops.

The ash content of the wood is approximately one per cent by weight. Most of the ash and also some fine charcoal fall down into the ash collection chamber, through the lower grate of the gasifier. Normally the grate is moved from time to time by mechanical means. The ash is taken out through a gas-tight service opening, with an automatic ash removal system. This is done with two to three day intervals.

From the gasifiers the gas is first passed through multi-cyclones (one per gasifier), which separates most of the dust and fly ash dragged by the gas. The amount separated has been on average 0.1% of the dry wood-fuel fed to the gasifiers.

After the cyclones the gas is led through water-scrubbers, coolers, and filters to a secondary charcoal filter, where the final impurities and moisture content of the gas is separated. Before the clean and dry wood gas is finally fed to the engines, it is slightly compressed, with the aid of an electrically driven compressor and stored in a buffer tank.

Figure 6.4 shows a typical commercial Imbert gasifier-engine unit, from which the ones at Loma Plata are slightly modified.

Figure 6.3 An extra air-injection device installed in the gasifiers

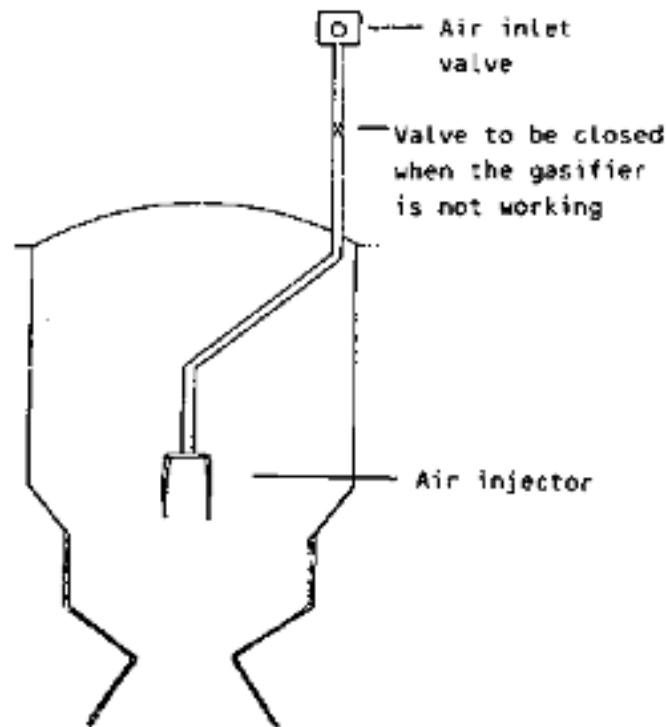
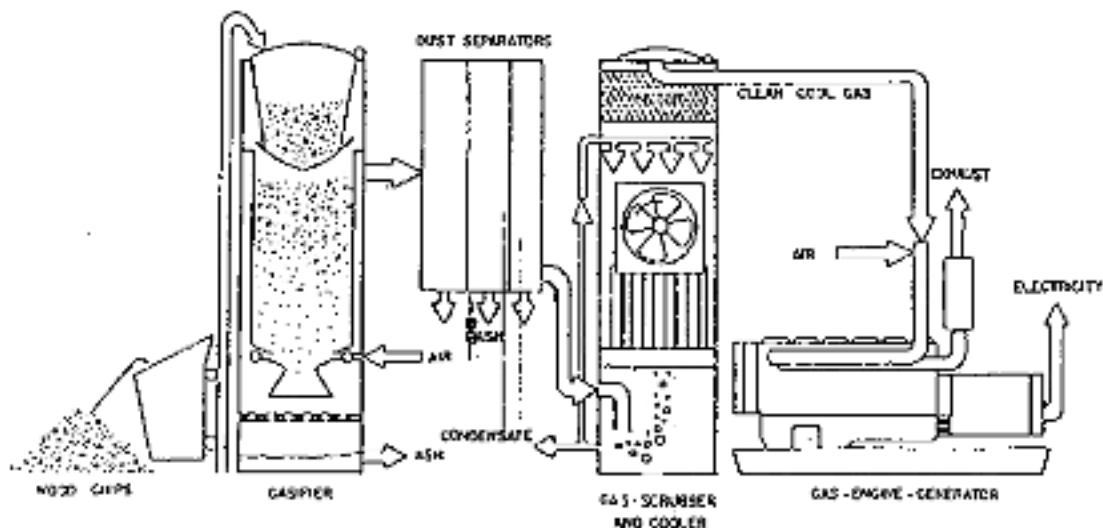

Figure 6.4 Schematic diagram of a typical Imbert gasifier-engine-generator unit



6.4 Electricity production with the gas engine alternator sets

The gasifiers feed three Waukesha L 7042 G engine alternator sets, with following technical data: 12 cylinder V-formed engines, with a cylinder volume of 115.4 dm³, bore/stroke diameter of 238/216 mm and compression ratio of 10:1. The nominal power output of the engines running on diesel oil is 859 kW each at 1200 rpm.

The engines have been converted to producer gas operation in the normal way by installation of special spark plugs, gas/air mixers, control devices, etc. Running on wood-gas the nominal power output is 525 kW at 1000 rpm. With $\cos(\phi) = 0,8$ for the 50 Hz, 400/230 V alternator, each set can generate 420 kVA electricity.

During the first one and a half years of operation, in 1983-84, the power-plant produced 4703 MWh electricity, with a total wood-fuel consumption of 8890 tons. This means that the average fuel consumption per produced kWh was 1.89 kg of woodchips, with a moisture content of 20-25%. During the same period the engines in operation consumed 9640 litres of lubricating oil.

Calculating with an average load factor of 68%, during 24 hours per day and 300 days per year, each gasifier engine unit generates roughly 2060 MWh electricity annually. The estimated electricity demand of the Loma Plata community is given in Table 6.3.

Table 6.3 The Electricity Demand at Loma Plata (9)

Consumer/Year (MWh/a)	1983 ^{1/}	1984 ^{1/}	1985 ^{2/}	1986 ^{2/}
Industry		2958	4048	5200
Public buildings		1015	1117	1335
Various (bakeries, dairies carpenters, etc.)		256	316	410
Other		185	258	515
Total	3089	4414	5739	7460

^{1/} Actual

^{2/} Projected

6.5 Operating experiences

After installation and test-running of the two first gasifiers, some problems with the presence of tar in the scrubbers, filters and engines occurred. Very high temperatures in the gasifiers were also registered. These abnormalities or difficulties were not observed, when the equipment was tested in Germany before delivery to Paraguay. The reasons for this were expected to lie in the fact, that during the test-runs in Germany the wood fuel used was a local pine while the wood-fuel in Chaco was of Quebracho blanco origin.

As a first measure the two wood-fuels under question were analyzed in more detail, and the results indicated following facts:

1 The tar and ash contents of the Quebracho-wood were twice as high as the respective values for the German pine.

2. The heat value of the Quebracho wood was also higher.

To solve the above-mentioned problems with tar contamination an extra air-injection device, as shown in figure 6.3, was installed in the gasifier, and an extra secondary charcoal filter was taken into use. To be able to lower the temperatures in the reactor the gas volume had to be decreased by 30%. This of course had a negative influence on the gasifier capacity. In the design of the third gasifier unit, these experiences were taken into account and resulted in a somewhat modified outfit, as mentioned in Section 6.3. In 1985 the gasifiers have worked more or less trouble-free and the maintenance and repair costs have decreased by roughly 40%. (9)

6.6 Profitability of using wood gas at Loma Plata

The generation of electricity with wood gas at Loma Plata has turned out to be a successful and profitable operation, compared to the alternative of using diesel oil as a fuel. The price of diesel oil has gone up from 72 ₡/l in June 1983 to 127 ₡/l in December 1984. During this period the cost of the wood chips has been on average 2.9 ₡/kg, which is more than six times the price of wood-fuel at the Sapire sawmill (see Chapter 4), but is still a very favourable cost compared to the price of diesel oil.

Production of 1 kWh electricity consumes 1.89 kg of wood-fuel at a cost of 5.48 ₡, while the corresponding number for diesel oil would be 0.34 l and 34 ₡, calculating with an average oil price of 100 ₡/l.

Table 6.4 Electricity Generation Costs Using Wood Gas at Loma Plata (9)

Year	Wood-fuel ₡	Lubricants ₡	Operation ₡	Maintenance ₡	Total ₡
1983	4212365	897000	1581216	916850	7667431
1984	21542100	3923000	4671000	18337000	48473100
Total	25814465	4820000	6252216	19253850	56140531

During this period the total electricity production was 4703650 kWh, which gives an average unit cost of 11.93 ₡/kWh. The share of the lubricating oil of the final costs was 1.02 ₡/kWh, and the share of the maintenance costs 4.09 ₡/kWh. The total investment costs of the power-plant (excluding the third gasifier unit) was 319 million ₡ and the share of the equipment costs 208 million ₡.

Calculating with a real interest rate of 10% and a depreciation time of eight years the annual capital costs for the installations are 59.3 M ₡ or equivalent to 11.9 ₡/kWh, with an estimated average electricity production of 5000 MWh per year. This means total electricity production costs of 23.8 ₡/kWh, which is only half of the actual electricity price of 1984, 46 ₡/kWh.

The pay-back time for the whole project has been estimated to roughly 6.5 years. The net annual savings in fuel costs by using wood instead of diesel-oil for year 1984 was over 100 million ₡.

All the economic numbers calculated above, clearly indicate the profitability of using wood-gas for electricity generation at the Loma Plata power-plant. The other positive socio-economic impacts of using biomass-based power generation on the agricultural and industrial activity within the Chortitzer cooperative are difficult to express in numbers but are obvious.

Exchange Rates	
June 1983	1 US\$ = 160
June 1984	1 US\$ = 360
September 1984	1 US\$ = 445
January 1985	1 US\$ = 377
April 1985	1 US\$ = 455
July 1985	1 US\$ = 625
January 1986	1 US\$ = 635

Chapter 7 - The future of wood gas as engine fuel

7.1 Prerequisites for extensive use of wood gasifiers

There should be no doubt that wood gasifiers have played an important role in the past, when liquid fuels for internal combustion engines were unavailable or expensive. It is also obvious that there has been an increasing interest in this technology since the middle of the seventies among scientists, energy planners, international development assistance agencies and government officials in some countries as a means of reducing the oil bill in oil importing countries with large biomass resources. But so far there are very few installations in commercial operation, where the gas is used to operate an internal combustion engine.

It is clear that the technology can have a future role in oil importing countries as an emergency option even though Sweden appears to be the only country which has officially taken the decision to make preparations for a conversion of vehicles to wood gas operation.

By all probability wood gas will not have a future as a regular engine fuel. Table 7.1 lists critical questions which all must be answered with 'yes' if its more general use is to be promoted. Answers based on the present situation in Sweden and in the Third World and a brief discussion of possible changes of the present situation are also provided.

7.2 Industrialized countries

In Sweden the present unfavourable economic situation for wood gasification is the main reason why there are only a few plants for testing purposes in operation. The unfavourable economy is a consequence of the fact that the cost difference between petroleum fuels and electricity on the one hand and fuel wood on the other is not high enough to cover the high labour and capital costs of the gasifier system.

It is an interesting observation that the price of petroleum fuels in constant value in Sweden is presently not much different from what it was in the 1930's and is in fact lower than just after the Second World War. Only during the war was the price significantly higher. In general, similarly unfavourable economic conditions apply for wood gasifiers in most countries in the industrialized world with the possible exception of industries with a surplus of residual biomass fuels.

The situation will change only if there are substantial increases in oil prices or in the cost of electricity. Such a development is foreseen in the present energy policy of Sweden, which aims at increasing taxes on imported fuels and abolishing nuclear power before the year 2010, but it is not until after the year 2000 that economic conditions may have changed in favour of wood gasifiers.

It can be concluded that there appears to be no immediate future for wood gas as engine fuel in the industrialized countries. Wood gasifiers may be economic under some special circumstances, like at industries with a surplus of biomass residues but the impact on the energy balance will be negligible. This does not mean that there is no need to keep the technology alive and improve on it. The situation may have changed by the end of the century, and wood gasification is still the only realistic emergency alternative for many countries.

7.3 Developing countries

In developing countries, as indicated in Table 7.1, the obstacles to wide use of wood gasifiers are quite different. As shown by several examples in this publication, the present economy of using wood gasifiers seems very promising in countries with low labour costs, in particular at locations with high oil prices.

Availability of biomass fuel may be a critical obstacle in some countries. For many of these the technical potential for making biomass fuels available for new uses exists through conservation (e.g. improved cooking stoves) or increased production (energy plantations). What is lacking in these countries is mainly political opportunity or will to improve the availability of biomass fuels.

Other obstacles to utilization of wood gas as engine fuel in developing countries are lack of know-how and lack of commercially available equipment. It can only be hoped that this publication and other information dissemination activities of FAO as well as of organizations such as the "Producer Gas Round Table" and the "Biomass Users Network" will contribute to the transfer of know-how to such an extent that this obstacle can be eliminated. The reasons why there is no commercial production of wood gasifier systems in the countries where this technology could be economic, and where, because of lower wages, there appear to be possibilities to build cheap equipment, must be sought in the lack of know-how discussed above, lack of capital for starting such enterprises but perhaps more important a lack of a real market for the products.

Table 7.1 Assessment of present and possible future prerequisites for extensive use of wood gas as engine fuel

Questions which must be answered with 'yes' if wood gas is to be used regularly as engine fuel	EVALUATION			
	Industrialized countries		Developing countries	
	Present situation	Possible changes in the future	Present situation	Possible changes in future
1. Is there sufficient economic incentive?	No	Government policy aims at promoting domestic fuels. Probably no impact on gasifier economy during this century.	Yes	Increasing wages as a result of economic development would make gasifiers less profitable.
2. Is there suitable biomass fuel available commercially, and can use of biomass fuel for gasifiers be sustained?	Yes	The situation will probably be improved as a result of present energy policy and ongoing research and development	In some countries, Yes	Present excessive use of biomass fuels can be reduced and methods adopted for use of biomass for new purposes
3. Is the necessary know-how of design, production and operation of biomass gasifiers available?	Yes	The practical knowledge is at present found with a small number of persons. The knowledge must be kept alive or it may vanish.	Generally, No	Information dissemination and training courses arranged by international development assistance organizations may improve the situation.
4. Is the necessary equipment commercially	Yes, but not in mass production.		Yes, but manufactured at high cost in	Production technology is comparatively simple. If know-how and necessary

available?			Europe or USA.	capital were available and if a reasonably large market existed, production could be started in many countries.
5. Can the economy be assessed by the users on basis of experience from locally operated plants?	Yes		No (with a few exceptions)	The situation can be improved by installation of demonstration plants.
6. Is the necessary capital for investment in equipment available to the users?	Yes		Probably not (with some exceptions)	Depends on the possibilities to borrow money for this purpose. Government programme is probably necessary to improve the situation in a short time
OVERALL ASSESSMENT	No role for wood gasifiers, except as emergency option.	Increasing oil prices may change the situation	Several obstacles to extensive use	All obstacles can be removed. Changes in the near future will require government action. and international assistance.

It may perhaps appear strange that there is no real market. It is true, as has been shown earlier in this publication, that Use of wood gas as engine fuel can be very economic in developing countries. It must be realized, however, that lack of capital for the investment required in equipment, in combination with lack of easily accessible and reliable data which can be used to assess economic feasibility, can be a major obstacle.

If it is assumed that the relative size of an investment can be assessed by calculation of the ratio between the investment and the wages, it is an interesting observation that the marginal investment for a gasifier system in Europe might be equivalent to about 15 working hours/kW installed capacity ^{1/}, whereas in a developing country, as can be inferred from estimates in chapters 4 and 5, the marginal investment could be equivalent to 80 - 200 working hours/kW, or even more for equipment built as single units in Europe, used in a developing country with low wages. It is therefore understandable that investments in gasifier equipment will depend to a large extent on borrowed money. The availability of loans for such purposes may be a limiting factor and in any case it will be necessary to convince the lending institutions that the investment will be profitable.

^{1/} During the Second World War the marginal investment amounted to about twenty working hours/kW.

This might be difficult if there is no favourable local experience of the technology.

It appears that these obstacles can only be eliminated in a reasonably short time if there is a strong government programme for the introduction of producer gas technology, including installation and operation of demonstration plants, cheap loans to pioneer users and organization of the fuel supply.

This was how producer gas was introduced in Sweden during the Second World War, see Chapter 3 or (1) for more details. This was how it was done in Germany during the same

period, see Graf (16), and this is how it is now done in the Philippines, see Baja (4). The programme in the Philippines has been focussed on charcoal gasification but the same introduction problems will affect wood gasifiers.

The conclusion is that the future of wood gasification technology in developing countries depends mainly on whether or not there will be government initiatives to promote this technology to substitute imported petroleum fuels with biomass. It will probably also be necessary that such programmes receive financial support from international development assistance organizations. At present such support is provided to demonstration projects in a large number of countries, and it can perhaps be expected that this will develop into support for programmes with a broader scope.

The World Bank, for the United Nations Development Programme (UNDP), initiated in July 1983 a programme to monitor and compile uniform data on the actual field performance, reliability, economics, safety and public acceptability of biomass gasifiers currently operating in developing countries (29).

The results of the monitoring programme will be used to:

- (i) determine if gasifiers are meeting the technical, economic and operational expectations of those currently utilizing the technology;
- (ii) identify the gasifier technologies, fuel resources and operating conditions most likely to ensure successful projects;
- (iii) identify aspects of the technology in need of additional research and development;
- (iv) establish standards to evaluate the acceptability of proposed gasifier projects; and
- (v) define the scope for the application of biomass gasifiers in developing countries.

The project will ideally encompass a three-year period. During the first phase of the programme, the gasified installations listed in Table 7.2 will be monitored (29), and the groundwork for the effective monitoring of six UNDP/EEC power gasifier projects in the South Pacific will be laid. The second year will continue the first mentioned activities, initiate full-scale monitoring of installed South Pacific gasifiers and possibly add to the programme existing installations in Latin America and Africa. In addition, country case studies that define the role of gasifier technology in meeting national energy needs will be prepared for Brazil and the Philippines. Finally, monitoring of the newly emerging heat gasifier technology will be substituted in the third year.

Table 7.2 Characteristics of Gasifiers Monitored in Phase 1 of the UNDP/World Bank Programme (29)

<u>Country</u>	<u>Location</u>	<u>Make</u>	<u>Capacity</u>	<u>Design*</u>	<u>Feedstock</u>	<u>End Use</u>
BRAZIL	1) Prudente de Morais	Embrabi	100 HP	DD	Charcoal	SI Engine/Water Pumping
	2) Itamarandiba	Siquierol	40 KVA	DD	Charcoal	SI Engine Electricity Generation
	3) Santa Luzia	Riedhammer	12 GJ/hr	UD	Charcoal	Clean gas for burners in a ceramic tunnel KILN
	4) Espera Feliz	Thermoquip	2 GJ/hr	DD	Wood	Burners for kaolin Drying
PHILIPPINES	1) Bago Loctugan, Roxas City	GEMCOR	38 HP	DD	Charcoal	Diesel/Irrigation Pumping
	2) Bolo Kaisa, Roxas city	GEMCOR	52 HP	DD	Charcoal	"
	3) Antique Kaisa Culasi	GEMCOR	75 KVA	DD	Charcoal	SI Engine Electricity Generation
	4) Maricban Island	GEMCOR	60 KVA	DD	Charcoal	SI Engine/Electricity Generation
MALI	Dogofiri	? - China	200 KVA	DD	Rich Hulls	"
KENYA	Ngong	Amica-Kenya	25 kW	DD	Charcoal	SI Engine/Water Pumping
BURUNDI	Tora	Everad-Belgium	45 KVA	DD	Peat	Diesel/Electricity Generation

* DD = Down Draughts; UD - Up-Draught

7.4 The need for international cooperation

It is certainly true that any country where wood gasifiers could be useful will be able to adapt, develop and introduce the technology without much assistance from other countries. A rapid introduction with a minimum of technical mistakes and disappointments in a country with no active experience of the technology will, however, require that the past and present experiences of European countries and the USA be utilized. On a general level such experiences are available from various non-profit organizations, but it is certainly true that when it comes to actually build equipment, the know-how and experience available from those manufacturers that have recently designed and built successfully operating equipment are essential. Commercial agreement with such manufacturers therefore appear the smoothest route to introduce wood gas as engine fuel.

Introduction of wood gasifiers will initially require some capital which may not be available in most developing countries. Support from international organizations can then be essential as discussed earlier. It should be observed that with the pay-back times estimated in this publication, the need for financial support will be of short duration, since very soon the improved economic situation resulting from lower oil bills may make economic resources available for further investments in wood gasifiers. It deserves mention that there might be benefits, in addition to any commercial advantages to be gained, for the industrialized countries to cooperate with developing countries in the introduction of wood gasifiers. The information feed-back from practical operation of modern engines could be of great value in the case of a petroleum fuel supply crisis.

There is finally a need for joint efforts for improved understanding of and finding ways to reduce the health hazards and possible environmental impacts of wood gas operation. Despite the very promising economy of this technology it may be necessary to limit the use of it to special applications and as an emergency option if the health risks and environmental pollution cannot be mastered. Chronic poisoning and disposal of tarry condensates appear as the most potentially serious in a long term perspective. Careful monitoring of the experiences and exchange of information from such programmes should be given high priority for international cooperation.

Appendix 1 - Calculation of the power output of a producer gas engine

The gasifier will be designed for an engine of the following specifications:

Bore:	84.14 mm
Stroke:	80 mm
Displacement (D):	3.56 l

$$\text{Max. air/gas intake: } \frac{1/2 \times (\text{rpm}) \times D}{60 \times 1000} = 0.045 \text{ m}^3/\text{s}$$

Air/gas ratio (stoichiometric): 1.1: 1.0

$$\text{Max. gas intake: } \frac{1.0}{2.1} \times 0.045 = 0.0212 \text{ m}^3/\text{s}$$

The real gas intake is $0.0212 \times f$, in which

f = volumetric efficiency (%) of the engine and -is dependent on:

- rpm of the engine
- design of the air inlet manifold of the engine
- fouling of the air inlet manifold of the engine

At 1500 rpm, for a well designed and clean air inlet manifold f can be taken at 0.8 -

Therefore the real gas intake is: $0.0212 \times 0.8 = 0.017 \text{ m}^3/\text{s}$

The heat value of the gas is taken at: 4800 kJ/m^3

Therefore the thermal power in the gas is:

$$P_g = 0.017 \times 4800 = 81.6 \text{ kJ/s} = 81.6 \text{ kW}$$

The engine efficiency depends partly on the engine's compression ratio. For a compression ratio of 9.5 : 1, the efficiency can be estimated at 28 percent.

Therefore the maximum mechanical output of this engine is:

$$P_M \text{ max.} = 81.6 \times 0.28 = 22.85 \text{ kW}$$

The maximum electrical output (cos phi generator = 0.8) is therefore:

$$P_E \text{ max.} = 22.85 \times 0.8 = 18.3 \text{ kVA}$$

Appendix 2 - Design calculation of downdraught gasifier

The gasifier will be designed for operation in conjunction with the engine from Annex I.

A. Biomass consumption gasifier

The thermal efficiency of the gasifier is taken at 70 per cent

Thermal power consumption (full load): $P_g/0.7 = 116.6$ kW

Heating value of biomass (14% moisture content): 17000 kJ/kg

Biomass consumption gasifier: $116.6/17000 = 0.0069$ kg/s = 24.7 kg/in

So the installation under consideration uses $24.7/18.3 = 1.35$ kg biomass to produce 1 kWh electricity.

B. Reactor design

For a double throat gasifier (see Chapter IV) holds:

$$B_{\xi \text{ max.}} = 0.9 \text{ m}^3 / \text{cm}^2 \text{ h} = \frac{\text{gas intake engine}}{\text{surface area "throat"}}$$

$$B_{\xi \text{ max.}} = 0.9 = \frac{0.017 \times 3600}{S}$$

$$S = \text{surface area "throat"} = 68 \text{ cm}^2 = 1/4 \times (\text{"throat"})^2 \times d_{\text{throat}} = 9.3$$

The turn down ratio of this type of gasifier can be estimated at a factor 3 (see Chapter 3).

So at loads below 6.1 kVA, tar production of this installation can be expected.

C. Further gasifies dimensions

Once the throat diameter has been fixed, further important gasifier dimensions can be derived from figures 3.3. and 3.4 (Chapter 3).

1. Height h of the nozzle plane above the smallest cross-section of the throat ($d_{\text{throat}} = d_t$).

$$h/d_t = 1.15$$

$$h = 1.15 \times 9.3 = 10.7 \text{ cm}$$

2. Diameter (d_r) of the fire box.

$$d_r/d_t = 3.0$$

$$d_r = 3.1 \times 9.3 = 29 \text{ cm}$$

3. Diameter (d_{r1}) of nozzle top ring

$$d_{r1}/d_t = 2.3$$

$$d_{r1} = 2.3 \times 9.3 = 21.4 \text{ cm}$$

4. Nozzle diameter (d_n)

Assumption: gasifier to be equipped with 5 nozzles

Total nozzle area (A_n): $5 \times 1/4 \times \pi \times d_n^2$

$$\frac{100 \times A_n}{A_t} = \frac{100 \times 5 \times 1/4 \times \pi \times d_n^2}{1/4 \times \pi \times d_n^2} = 62$$

$$d_n = 10.4 \text{ mm}$$

Table of conversion factors and symbols (used in this manual)

Energy Units
J = Joule
kJ = 1000 J
GJ = 1000000000 J
kWh = 3600000J
TWh = 3.6×10^{15} J

Power Units
W = Watt
kW = 1000 W
MW = 1000000 W
HP = Horse Power = 745.7 W
kVA = kilo Volt-Ampere

Force Units
N = Newton
kgf = force kilogram 1 kgf = 9.8067 N
t = ton = 1000 kgf

Pressure Units
Pa = Pascal = N/m ²
kgf/cm ² = 98067 Pa
mm Wg = 9.8067 Pa
cm Wg = 98.067 Pa
atm = 1.0133×10^5 Pa

Length Units
m = meter
cm = 0.1 m
mm = 0.001 m
km = 1000 m
μ m = 0.000.001 m

Surface Units
m ² = square meter

cm = 0.01 m

Mass Units

kg = kilogram

mg = 0.000.001 kg

g = 0.001 kg

Time Units

s = second

min = minute = 60 s

h = hour = 3600 s

yr = year

Volume Units

m³ = cubic meter

dm³ = 0.001 m³

mm³ = 0.000000001 m³

l = litre = 1 dm³

Temperature Units

K = Kelvin

°C = degree Celsius

1° C = 1 K

Miscellaneous

Nm³ = normal cubic metre (at 1 atm and 0°C)

mol = quantity of matter unit

gram atom = atomic weight expressed in grams

gram molecule = molecular weight expressed in grams

ppm = parts per million

rpm = revolutions per minute

° = angular degrees

person-km = one person transported one km

ton-km = one ton transported one km

man-yr = one man working one year

Other Units

Hz = Hertz (frequency)

V = Volt

Currencies

US\$ = U.S.A. dollars

₡ = Guaranies

ƒl = Dutch florin

References

1. Axelsson, R. 1969a. Summary of laboratory tests with producer gas operation of tractor Massey Ferguson 1100 (in Swedish). Statens Maskinprovningar, Umea, Sweden.
2. Axelsson, R. 1969b. Sweden. Summary of tests with producer gas truck Scania L80 (in Swedish). Statens Maskinprovningar, Umea,
3. Bailey, M.L. 1979. Gas producers for vehicles - An historical review. Department of Scientific and Industrial Research, New Zealand. Rep. No. CD 2279.
4. Baja, L. 1983. Promotion of producer gas projects in the Philippines. Ibid. p. 519-527.
5. Beagle, E.C. Ricehusk: 1978. Conversion to energy, FAO Agricultural Service Bulletin No. 31, Rome, Italy.
6. Beagle, E.C. 1982. Gasifier-Stirling, an innovative concept, 1st Int. Prod. Gas Conf., Colombo, Sri Lanka.
7. Beenackers, A.A.C.M. and Van Swaaij, W.P.M. 1982. Gasification of biomass, a state-of-the-art review, Press. 1st Eur. Workshop on thermochemical processing of biomass. Birmingham, U.K.
8. Brandini, A. 1983. Experiencias con gasificadores en el Brazil. Manual del curve de gasificación de la madera en Centro America y el Caribe. Pp. 308-320. Olade, Costa Rica.
9. Cañete, N. (Chortitzer Cooperative, Paraguay). 1986. Personal correspondence with FAO.
10. Cruz, I.E. Producer gas from agricultural residue; its production and utilization in internal combustion engines, PNOG-ERDC, Diliman, Quezon City, Philippines.
11. Finkbeiner, H. Zeitschrift der Verein Deutsche Ingenieure, Germany. 1935
12. Foley, G. and Barnard, G. 1983. Biomass gasification in developing countries. Earthscan Technical Report No. 1. London, U.K.
13. Gasifier and Equipment Manufacturing Corporation (GEMCOR), 1982. Gasifier Applications, Manila, Philippines.
14. Giffen, E et al. 1946. The conversion of compression ignition engines to producer gas, Engineering, U.K.
15. Gore, W.T. 1981. Priorities in energy research with special assessment of biomass and producer gas. National Timber Research Institute, South Africa.
16. Graf, U. 1983. Strategies for implementing producer gas technology in developing countries - some limiting remarks. Producer Gas 1982, p. 529-545. The Beijer Institute, Stockholm, Sweden.
17. Groeneveld, M.J. Thesis, Twente University of Technology, Enschede, The Netherlands. 1980.

18. Höglund, C. 1981. Agricultural residues as fuel for producer gas generation. The Beijer Institute, Stockholm, Sweden.
19. Jenkins, B.M. 1980. Down-draught gasification characteristics of major California residue-derived fuels, Ph.D. Thesis, Engineering, University of California, Davis, U.S.A.
20. Kaupp, A. and Goss, J.R. 1981. State-of-the-art for small scale (to 50 kW) gas producer engine systems. Contract No. 53-319R0-141. Bioresources for Energy Timber Management Research, USDA, Forest Service.
21. Kaupp, A. 1982. The gasification characteristics of rice hulls for the generation of electricity and shaft power on a small (530 hp) scale, 1st Int. Prod. Gas Conf., Colombo, Sri Lanka.
22. Kissin, I. 1942. Gas producers for motor vehicles and their operation with forest fuels, Imperial Forestry Bureau, Oxford, U.K.
23. Kjellström, B. 1984. Hazards of producer gas operation: The Beijer Institute, Stockholm, Sweden.
24. Kulasinghe, A.N.S. 1983. Experiences with low cost gasifiers in Sri Lanka. Producer Gas 1982, pp. 279-300. The Beijer Institute, Stockholm, Sweden.
25. Kurkela, E. & Nylund, N.O. 1985. Production of wood and peat gas and its use in internal combustion engines (in Finnish), Report of Technical Research Centre of Finland, Espoo, 12 pp.
26. Leuchs, M. 1982. Measurements of a counter-current gasifier in connection with an engine of 125 kW electrical power, M.A.N. Neue Technologie, Munich, Germany.
27. Lindquist, T. 1984. Producer gas operation of vehicles with diesel engines (in Swedish). Statens Maskinprovningar, Umea, Sweden.
28. Mahin, D.B. (USAID) and Terrado E. Personal communication. (World Bank).
29. Mendis, M.S. 1984. UNDP/World Bank Guidelines for field monitoring of biomass gasifiers in developing countries. Proc. of the Conference "Bioenergy 84", Göteborg, Sweden, June 1984. Ed. by Egnerus, H. & Ellegard, A., Elsevier Applied Science Publishers, London, Vol. III. page 135-145.
30. Middleton, F.A. and Bruce, C.S. 1946. Engine tests with producer gas, Journal of Research of the National Bureau of Standards, U.S.A.
31. National Academy Press, Producer gas: Another fuel for motor transport. Washington, D.C., U.S.A. 1983.
32. National Research Council, Producer gas: another fuel for motor transport. Report of an ad hoc panel of the Advisory Committee on Technology Innovation. National Academy Press, Washington, D.C., U.S.A. 1981.
33. Nordstrom, O. 1963. Account of research and testing activities in the producer gas field at the National Swedish Testing Institute for Agricultural Machinery during 1951-1962, carried

out for the Swedish Board for Economic Defence (in Swedish). Statens Maskinprovningar, Uppsala, Sweden.

34. Schläpfer, P. and Tobler, J. 1937. Theoretischen und Praktische Untersuchungen über den Betrieb von Motorfahrzeuge mit Holzgas, Bern.

35. Shilton, P. 1982. Preliminary experience in the operation of a gasogen plant of classical Imbert design using mixed wood/coconut husks as a fuel, 1st Int. Prod. Gas Conf., Colombo, Sri Lanka.

36. Skov, N.A. and Papworth, M.L. 1974. The Pegasus unit. Pegasus publishers Inc. Olympia, Washington, U.S.A.

37. Sonnenberg, R.; Zerbin, W.O. & Krispin, T. 1985. 1.4 and 4.8 MW wood gas power plants in operation. Proceedings of the Third E.C. Conference on "Energy from Biomass", Venice, Italy March 1985, ed. Palz, W.; Coombs, J. & Hall, D.O., Elsevier Applied Science Publishers, London & New York, pp. 1127 - 1121.

38. Spoon, W. 1940. Heutvergassing in de tropen in hot bijzonder met het cog op Nederlandseh Indie en Suriname, De Indische Merkuur, Batavia, Indonesia.

39. Stassen, H.E.M. 1980. The gasification by partial combustion project in Tanzania, Twente University of Technology Report, Enschede, The Netherlands.

40. Stassen, H.E.M. and van Swaaij, W.P.M. 1983 Application of biomass gasification in developing countries, 2nd E.C. Conference on "Energy from Biomass", ed. Strub, Chartier, Schloser, Applied Science Publishers, London & New York.

41. Susante, H. et al. 1982. Moving bed gasifier with internal recycling of pyrolysis gas, 1st Int. Prod. Gas Conf., Colombo, Sri Lanka.

42. Tiedema, P., van der Weide, J. and Dekker, H.J. 1983. Converting diesel engines to the use of gaseous fuels. Producer Gas 1982, p. 393-414. The Beijer Institute, Stockholm, Sweden.

43. The Swedish Academy of Engineering Sciences. 1979. Generator Gas - The Swedish Experience from 1939-1945. Translated by the Solar Energy Research Institute, U.S.A. SERI/SP-33-140.

44. Van der Aarsen, F.G. et al. 1982. Performance of a rice-husk fluidized bed pilot plant gasifier, 1st Int. Prod. Gas Conf., Colombo, Sri Lanka.

45. Vedgasen. Ett alternative i Frankrike. 1983. Trailer No. 4, p. 34.

46. Venselaar, J. 1982. Design rules for down-draught gasifiers, a short review, IT Bandung, Indonesia.

47. Zhiang Fang. 1983. The progress of research work on gasification of agricultural residues in China. FAO second expert consultation on producer gas development in Asia and the Pacific Region, Bangkok, Thailand. p. 272-95.

48 Zijp, T. and Stassen, H.E.M. 1982. Gasification of maize spills for mechanical energy generation in rural areas in Tanzania. 1st Int. Prod. Gas Conf., Colombo, Sri Lanka

Tipo-lito SAGRAF - Napoli

FAO TECHNICAL PAPERS

FAO FORESTRY PAPERS:

1. Forest utilization contracts on public land, 1977 (E* F* S*)
2. Planning of forest roads and harvesting systems. 1977 (E* F* S*)
3. World list of forestry schools, 1977 (E/F/S*)
- 3 Rev. 1 - World list of forestry schools, 1981 (E/F/S*)
- 3 Rev. 2 - World list of forestry schools, 1986 (E/F/S*)
4. World pulp and paper demand, supply and trade

Vol. 1, 1977 (E* F* S*)

Vol. 2, 1978 (E* F* S*)

5. The marketing of tropical wood in South America, 1978 (E S*)
6. National parks planning, 1978 (E* F* S****)
- 7 Forestry for local community development 1978 (E* F* S*)
- 8 Establishment techniques for forest plantations, 1978 (Ar**** C* E** F* S*)
9. Wood chips, 1978 (C* E* S*)
10. Assessment of logging costs from forest inventories in the tropics, 1978

1. Principles and methodology (E* F* S*)
2. Data collection and calculations (E* F* S*)

11. Savanna afforestation in Africa, 1978 (E* F*)
12. China: forestry support for agriculture, 1978 (E*)
13. Forest products prices, 1979 (E/F/S*)
14. Mountain forest roads and harvesting, 1979 (E*)
- 14 Rev. 1 - Logging and transport in steep terrain, 1985 (E*)
15. AGRIS forestry wood catalogue of information and documentation services, 1979 (E/F/S*)
16. China: integrated wood processing industries, 1979 (E* F* S****)
17. Economic analysis of forestry projects, 1979 (E* F* S*)
17. Sup. 1 - Economic analysis of forestry projects: case studies. 1979 (E* S*)
17. Sup. 2 - Economic analysis of forestry projects: readings, 1980 (E*)
18. Forest products prices 1960-1978, 1980 (E/F/S*)
19. Pulping and paper-making properties of fast-growing plantation wood species

Vol. 1. 1980 (E*)

Vol. 2. 1980 (E*)

- 20/1. Forest tree improvement, 1985 (E* F* S*)
- 20/2 A guide to forest seed handling, 1985 (E*)
21. Impact on soils of fast-growing species in lowland humid tropics. 1980 (E* F*)
- 22/1. Forest volume estimation and yield prediction, 1980

Vol. 1 - Volume estimation (E* F* S*)

22/2. Forest volume estimation and yield prediction, 1980

Vol. 2 - Yield prediction (E* F* S*)

23. Forest products prices 1961-1980, 1981 (E/F/S*)
 24. Cable logging systems, 1981 (E*)
 25. Public forestry administration in Latin America, 1981 (E*)
 26. Forestry and rural development, 1981 (E* F* S*)
 27. Manual of forest inventory, 1981 (E* F*)
 28. Small and medium sawmills in developing countries, 1981 (E* S*)
 29. World forest products, demand and supply 1990 and 2000. 1982 (E* F* S*)
 30. Tropical forest resources, 1982 (E/F/S*)
 31. Appropriate technology in forestry, 1982 (E*)
 32. Classification and definitions of forest products, 1982 (Ar/E/F/S*)
 33. Logging of mountain forests, 1982 (E*)
 34. Fruit-bearing forest trees, 1982 (E* F* S*)
 35. Forestry in China, 1982 (E*)
 36. Basic technology in forest operations, 1982 (E* F* S*)
 37. Conservation and development of tropical forest resources. 1982 (E* F* S*)
 38. Forest products prices 1962-1981, 1982 (E/F/S*)
 39. Frame saw manual, 1982 (E*)
 40. Circular saw manual, 1983 (E*)
 41. Simple technologies for charcoal making, 1983 (E* F* S*)
 42. Fuelwood supplies in the developing countries, 1983 (Ar* E* F* S*)
 43. Forest revenue systems in developing countries, 1983 (E*)
 - 44/1. Food and fruit-bearing forest species, 1983 (E* F*)
 - 44/2. Food and fruit-bearing forest species, 1984 (E* F* S*)
 - 44/3. Food and fruit-bearing forest species, 1986 (E*)
 45. Establishing pulp and paper mills, 1983 (E*)
 46. Forest products prices 1963-1982, 1983 (E/F/S*)
 47. Technical forestry education - design and implementation, 1984 (E*)
 48. Land evaluation for forestry, 1984 (E* S*)
 49. Wood extraction with oxen and agricultural tractors, 1986 (E* F* S*)
 50. Changes in shifting cultivation in Africa, 1984 (E* F*)
 - 50/1. Changes in shifting cultivation in Africa - seven case-studies, 1985 (E*)
 - 51/1. Études sur les volumes et la productivité des peuplements forestiers tropicaux
-
- 1: Formations forestières sèches, 1984 (F*)
-
- 52/1. Cost estimating in sawmilling industries: guidelines, 1984 (E*)
 - 52/2. Field manual on cost estimation in sawmilling industries, 1985 (E*)
 53. Intensive multiple-use forest management in Kerala (India). 1984 (E*)
 54. Planificación del desarrollo forestal, 1985 (S*)
 55. Intensive multiple-use forest management in the tropics, 1985 (E* F* S*)
 56. Breeding poplars for disease resistance, 1985 (E*)
 57. Coconut wood, 1985 (E S*)
 58. Sawdoctoring manual, 1985 (E*)
 59. The ecological effects of eucalyptus, 1985 (E* F* S*)
 60. Monitoring and evaluation of participatory forestry projects 1985 (E*)
 61. Forest products prices 1965-1984, 1985 (E/F/S*)
 62. World list of institutions engaged in forestry and forest products research, 1985 (E/F/S*)
 63. Industrial charcoal making, 1985 (E*)
 64. Tree growing by rural people, 1985 (E*)
 65. Forest legislation in selected African countries, 1986 (E* F*)
 66. Forestry extension organization, 1986 (E*)
 67. Some medicinal forest plants of Africa and Latin America, 1986 (E*)
 68. Appropriate forest industries, 1986 (E*)
 69. Management of forest industries, 1986 (E*)

- 70. Wildland fire management terminology, 1985 (E/F/S*)
- 71. World compendium of forestry and forest products research institutions, 1986 (E/F/S*)
- 72. Wood gas as engine fuel, 1986 (E*)
- 73. Forest products: world outlook projections, 1986 (E/F/S*)

Availability: November 1986

Ar - Arabic
C - Chinese
E - English
F - French
S - Spanish

* Available
** Out of print
*** In preparation

The FAO Technical Papers can be purchased locally through the authorized FAO Sales Agents or directly from Distribution and Sales Section, FAO, Via delle Terme di Caracalla, 00100 Rome, Italy.